

Worldwide Marketing & Sales

MAYPAK CO., LTD.

Add:Rm 1005, Blk A, Sunshine International, No.55 Yuli Rd,
Yuyao 315400, Zhejiang, China.

Tel:0086-574-62790606

Cell No. :0086-18657435151

Fax:0086-574-62790909

E-mail:sales@maypakcn.com

Http://www.maypakcn.com

Manufacturing Facility in Ningbo China

YUYAO S & M PACKAGING CO., LTD.

Add:No.15 Shiji Rd, Mazhu Developing Zone, Yuyao 315450,
Zhejiang, China.

Tel:0086-574-62795578

Fax:0086-574-62790909

Cell No.:0086-13958350674

E-mail:sales@smcospack.com

Http://www.smcospack.com

MayPak
美派包装



2016

S&M

SINCE 2006

We Can Design & Produce Private Molds Tooling For Packaging

Product Application



Our Factory

S&M designs, develops and manufactures plastic and metal spray dispensers and packages for the cosmetic, personal care and general merchandise industries. Our packaging products include plastic fine mist sprayers, plastic and metal crimp sprayers, lotion pumps, treatment pumps, airless dispensing containers, triggers and mini trigger sprayers, glass, plastic and acrylic bottles as well as plastic tubes.

S&M can design and produce molds for spray containers and closures with customized shapes, sizes, colors and decorations. Our innovative design and engineering department can develop new items quickly at reasonable costs.

S&M more than 10 years' experience in the packaging industry, we have focused on customer service and quality product for worldwide markets.

Factory Strength





Alibaba.com Assessed Supplier





Assessment Report

Presented to
Yuyao S&M Packaging Co., Ltd.
余城市欣蒙包装有限公司

Gold Supplier & Assessed Company Relationship:	<input checked="" type="checkbox"/> Self-owned <input type="checkbox"/> Wholly Owned <input type="checkbox"/> Shareholder/Partner <input type="checkbox"/> Kindred between Owners
Company Address:	No. 15, Shiji Road, Mazhu Town, Yuyao City, Ningbo City, Zhejiang Province, China
City / Country:	Yuyao / China
Consigner of Assessment:	Alibaba
Gold Supplier Member ID:	smcospack
Gold Supplier Company Name:	Yuyao S&M Packaging Co., Ltd.
Contact Person:	Ms. Guoying Huang
Phone Number:	0086-574-62795578
Fax Number:	0086-574-62790909
Email:	sales@smcospack.com
Website Address (URL):	http://smcospack.en.alibaba.com

Service provided by TÜV Rheinland
Report No.: 5323440_P+T

Contents

SM series

-  **SM1**
TRIGGER SPRAYERS
手扣式喷雾器系列 P04-11
-  **SM2**
LOTION PUMPS
乳液泵系列 P12-20
-  **SM3**
FOAM PUMPS
泡沫泵系列 P21-23
-  **SM4**
FINE MIST SPRAYERS
小喷雾系列 P24-31
-  **SM78**
ALUMINUM COLLARS
氧化铝中套系列 P32-33
-  **SM5**
MINI SPRAYERS
迷你喷雾器系列 P34-37
-  **SM6**
TREATMENT PUMPS
粉泵系列 P38-40
-  **SM7**
CAPS
盖子系列 P41-52

MP series

-  **MP1**
ROLL ON BOTTLES & DEODORANT STICKS
滚珠瓶/粉瓶系列 P54-57
-  **MP53&54**
ACRYLIC NAIL POLISH & SKIN ESSENCE BOTTLES
亚克力指甲油瓶/精华液瓶系列 P58-59
-  **MP2**
HIGH GRADE WHITE
PORCELAIN BOTTLE SETS
瓷白瓶系列 P60-61
-  **MP3**
GLASS BOTTLES
玻璃瓶系列 P62-64
-  **MP4**
PET & HDPE BOTTLES
PET瓶/HDPE瓶系列 P65-69
-  **MP43**
BATH SALT BOTTLES
浴盐瓶系列 P70-71
-  **MP5**
AIRLESS & LOTION BOTTLES
真空瓶/乳液瓶系列 P72-93
-  **MP6**
CREAM JARS
膏霜瓶系列 P94-99
-  **MP7**
ALUMINUM BOTTLES & JARS
铝瓶/铝罐系列 P100-102
-  **MP11**
AIR CUSHION COMPACTS
& LIPSTICKS
气垫BB霜/口红管系列 P103
-  **MP8**
PLASTIC TUBES
塑料软管系列 P104-105
-  **MP10**
COSMETIC PENS
化妆笔系列 P106-109

Trigger Sprayers /手扣式喷雾器

SM1 series

- With unique locking device push close, push open.
- Usage:
Room Fresheners / Perfumes /
Personal Care Products / Hair sprays

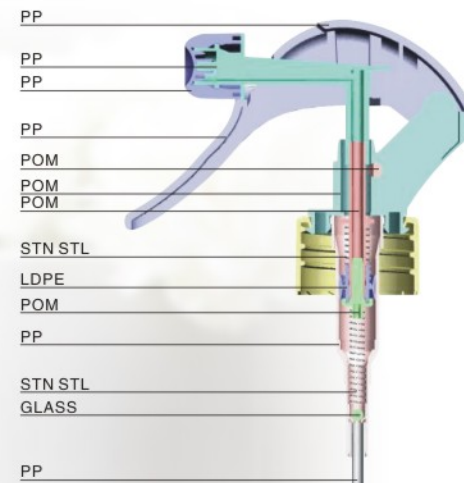

PATENT NO. ZL 2012 3 0440001.X

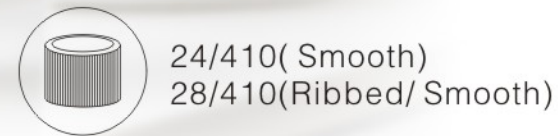

SM1104
Discharge rate:0.3ml/T
Closure:22/410, 24/410, 28/410



SM1105B
Discharge rate:0.3ml/T
Closure:24/410, 28/410



SM13A02
Discharge rate:0.15ml/T
Closure:24/410



SM13C02-B
Discharge rate:0.3ml/T
Closure:24/410, 28/410



SM13B01
Discharge rate:0.25-0.30ml/T
Closure:24/410



SM13B02
Discharge rate:0.25-0.30ml/T
Closure:28/410



SM12B01
Discharge rate:0.50-0.55ml/T
QTY:500PCS/CTN
Meas:57x32x39CM



SM12B02
Discharge rate:0.50-0.55ml/T
QTY:500PCS/CTN
Meas:57x32x39CM



SM13E
Discharge rate:0.26-0.30ml/T
Closure:24/410, 28/410
QTY:500PCS/CTN
Meas:48x35x40CM



SM13F
Discharge rate:0.3ml/T
Closure:24/410, 28/410
QTY:450-500PCS/CTN
Meas:43x32x38CM

Trigger Sprayers /手扣式喷雾器

SM1 series



SM1402

Discharge rate:1.3ml/T
Function:ON-OFF & FOAM
QTY:350PCS/CTN
Meas:50x35x40CM



28/400
28/410
28/415

NOZZLE OPTIONS



FOAM A



FOAM B



ON-OFF



SM1410A

Discharge rate:1.20-1.40ml/T
QTY:400PCS/CTN
Meas:54x38x38CM



SM1410B

Discharge rate:1.20-1.40ml/T
QTY:400PCS/CTN
Meas:54x38x38CM



SM1410C

Discharge rate:1.20-1.40ml/T
QTY:400PCS/CTN
Meas:54x38x38CM

NOZZLE OPTIONS



SPRAY/STREAM
A



ON/OFF FOAM
B



PLASTIC MESH/FOAM
C



SPRAY/STREAM
D

CLOSURE OPTIONS

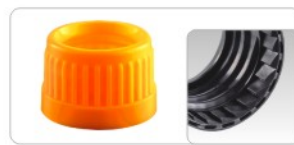

Ratchet

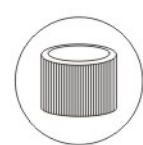

28/400
28/410
RATCHET



SM1501

Discharge rate:3.0-3.5ml/T
Closure:28/400
QTY:200PCS/CTN
Meas:56x37x40CM



SM1409

Discharge rate:3.5±0.15ml/T
Closure:28/400,28/410,28/415
Function:SPRAY-STREAM-OFF
QTY:300PCS/CTN
Meas:45x39x57CM



SM1406

Discharge rate:2.0±0.1ml/T
Closure:28/400
Function:SPRAY-STREAM-OFF
QTY:450PCS/CTN
Meas:45x39x57CM



SM1403

Discharge rate:0.9-1.0ml/T
Closure:28/400,28/410
Function:SPRAY-STREAM-OFF
QTY:500PCS/CTN
Meas:60x33x38CM



SM1405

Discharge rate:0.9±0.1ml/T
Closure:28/400,28/410,28/415
Function:SPRAY-STREAM-OFF
QTY:450PCS/CTN
Meas:45x39x57CM



SM1407

Discharge rate:0.9-1.1ml/T
Closure:28/400,28/410
Function:SPRAY-STREAM-OFF
QTY:500PCS/CTN
Meas:57x39x42CM



SM1408

Discharge rate:1.1±0.1ml/T
Closure:28/400,28/410,28/415
Function:SPRAY-STREAM-OFF
QTY:450PCS/CTN
Meas:45x39x57CM



Trigger Sprayers /手扣式喷雾器

SM1 series

- All plastic design makes the product highly compatible, recyclable and environmentally friendly.
- Special plastic spring offers soft feeling when pull the trigger.
- Positive ventilation reducing risk of bottle deformation.
- Various screw type options.
- Foam nozzle available.
- Household Cleaning products.
- Aggressive liquids.

All Plastic Environmental Protection
全塑环保



SM1801

Discharge rate: 1.20-1.40ml/T
Closure: 28/400, 28/410
QTY: 400PCS/CTN
Meas: 54x38x38CM



SM1802

Discharge rate: 1.20-1.40ml/T
Closure: 28/400, 28/410
QTY: 400PCS/CTN
Meas: 54x38x38CM



SM1803

Discharge rate: 1.20-1.40ml/T
Closure: 28/400, 28/410
QTY: 400PCS/CTN
Meas: 54x38x38CM

NOZZLE OPTIONS



SPRAY/STREAM A PLASTIC MESH/FOAM C SPRAY/SPRAY D

CLOSURE OPTIONS

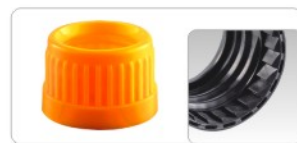

Ratchet



28/400
28/410
RATCHET

Dual color shroud 双色设计 造型独特

SM1804

Discharge rate: 1.40ml/T
Closure: 28/400, 28/410
QTY: 500PCS/CTN
Meas: 60x38x44CM



NOZZLE OPTIONS



FOAM SPRAY/OFF SPRAY/OFF/STREAM

TRIGGER OPTIONS



A B



28/400
28/410
RATCHET

Discharge rate: 1.20-1.40ml/T
QTY: 400PCS/CTN
Meas: 54x38x38CM

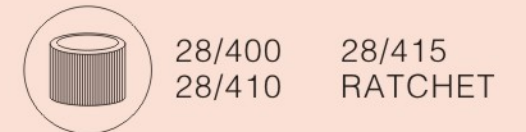

28/400 28/415
28/410 RATCHET



SM1805

Closure: 28/400, 28/410
Ratchet



SM1807

Closure: 28/400, 28/410
Ratchet



SM1806

Closure: 28/400, 28/410
Ratchet



SM1808

Closure: 28/400, 28/410, 28/415



Trigger Sprayers series

手扣式喷雾器系列

- Designed for excellent spraying efficiency high chemical compatability.
- Various styles of trigger designs, shrouds and nozzles.
- All standard closure sizes as well as ratchet.
- Usage:
Glass cleaner
Household chemicals and cleaners
Furniture polish
Garden and insecticide sprays

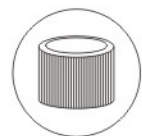
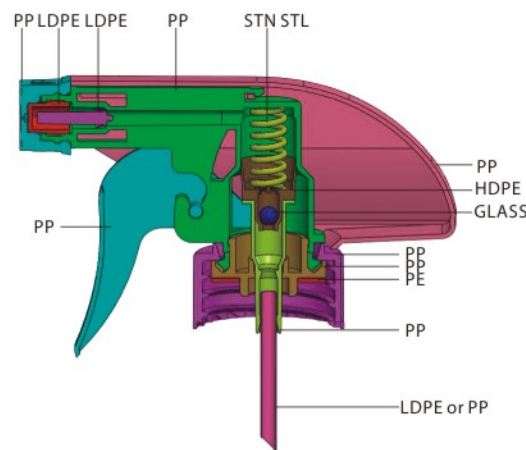

28/400 28/410
28/415 RACHET



SM1601
Discharge rate:0.75-0.80ml/T



SM1602
Discharge rate:0.75-0.80ml/T



SM1603
Discharge rate:0.75-0.80ml/T



SM1604
Discharge rate:0.75-0.80ml/T



SM1605
Discharge rate:0.75-0.80ml/T



SM1606
Discharge rate:0.75-0.80ml/T



SM1607
Discharge rate:0.75-0.80ml/T



SM1608
Discharge rate:0.75-0.80ml/T



SM1609
Discharge rate:0.75-0.80ml/T



SM1610
Discharge rate:0.75-0.80ml/T



SM1611
Discharge rate:0.75-0.80ml/T



SM1612
Discharge rate:0.75-0.80ml/T

NOZZLE OPTIONS

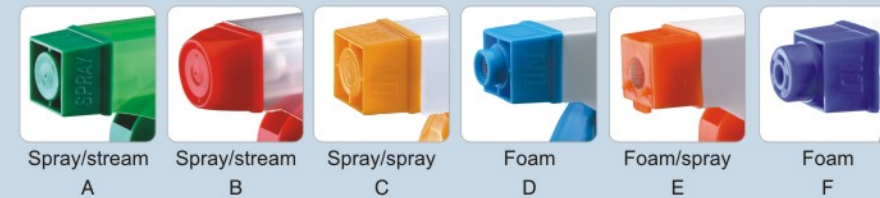

Spray/stream A Spray/stream B Spray/spray C Foam D Foam/spray E Foam F

TRIGGER OPTIONS

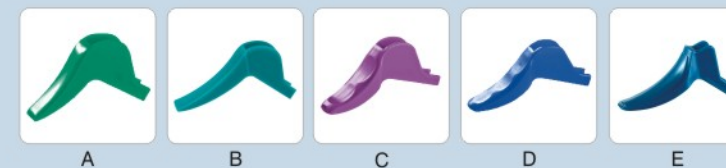

A B C D E

CLOSURE OPTIONS



28/400 28/410 28/415 RACHET



Lotion Pump series
乳液泵系列



Discharge rate:
1.20-1.50ml/T
Smooth / Ribbed / Aluminum

TWIST LOCK

- Various styles of dispensing heads
- Designed for comfortable and easy use



Various styles of heads options



Various closure size options



Various aluminum shell options

Lotion Pumps /乳液泵

SM22 series

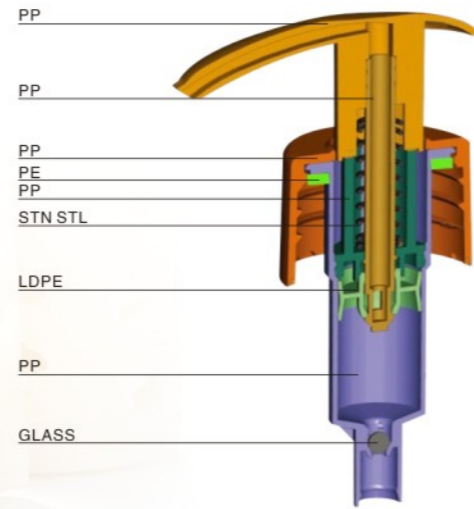

- With the spring outside to eliminate contact of metal to product

TWIST LOCK

Discharge rate:
2.00-2.20ml/T
Smooth / Ribbed / Aluminum



Various styles of heads options



Various closure size options

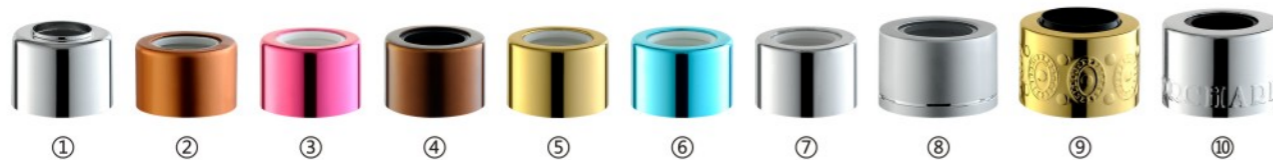

Various aluminum shell options

SM24 series

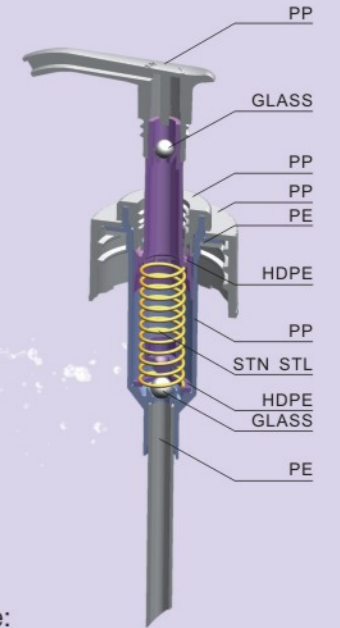

- Usage:
Hair Care & Hair gel / Bath & Body Wash /
Kitchen detergent soap

SCREW DOWN

Discharge rate:
2.00-2.20ml/T
Smooth / Ribbed / Aluminum

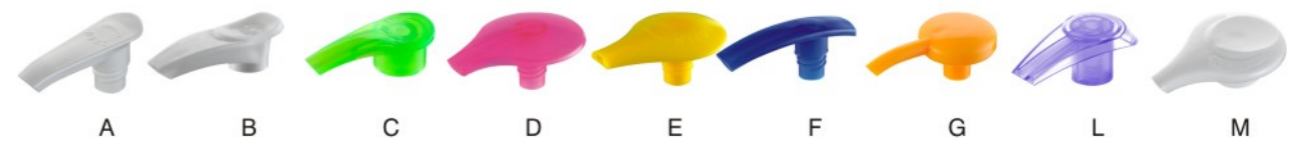

Various styles of heads options



Various closure size options

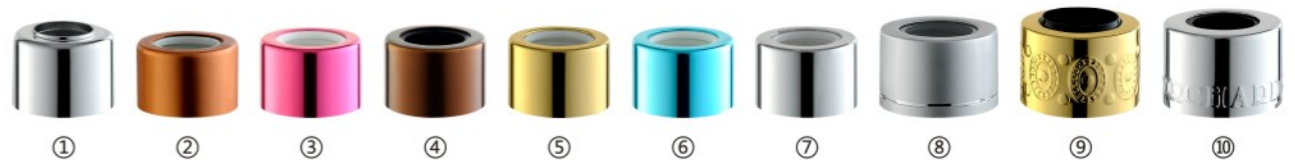

Various aluminum shell options

Lotion Pumps /乳液泵

SM23 series

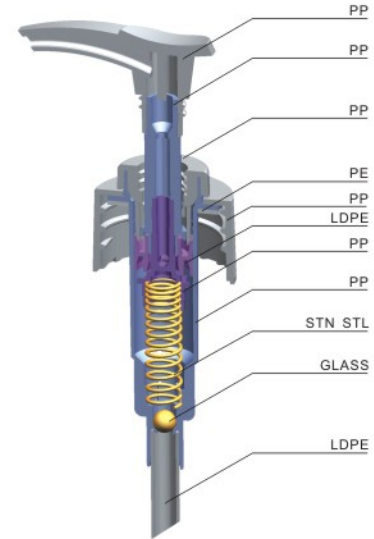

- Smooth and ribbed closures in all standard sizes as well as with aluminum shells over the closure.
- Many nozzle designs for easy of use.

Discharge rate:
1.80-2.00ml/T
Smooth / Ribbed / Aluminum

SCREW DOWN

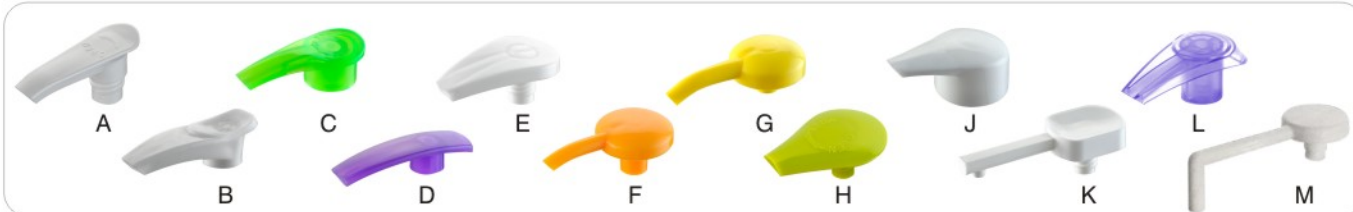

Various styles of heads options



Various closure size options

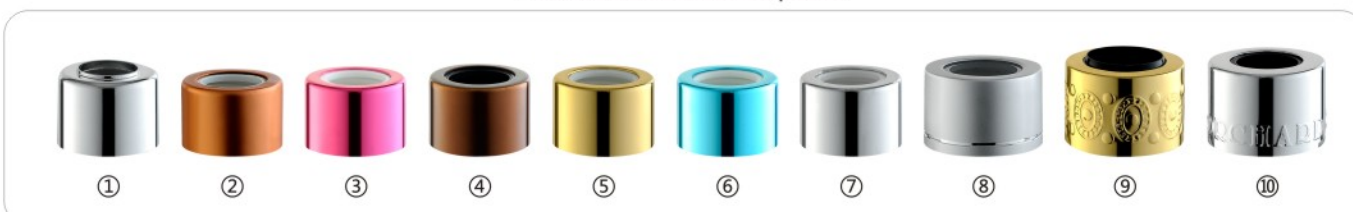

Various aluminum shell options

SM25C series



SM25C
Discharge rate:4.0ml/T
Closure:28/410

SM25C
Discharge rate:4.0ml/T
Closure:28/410

SM25C
Discharge rate:4.0ml/T
Closure:28/415

SM25C
Discharge rate:4.0ml/T
Closure:28/415

SM25A series

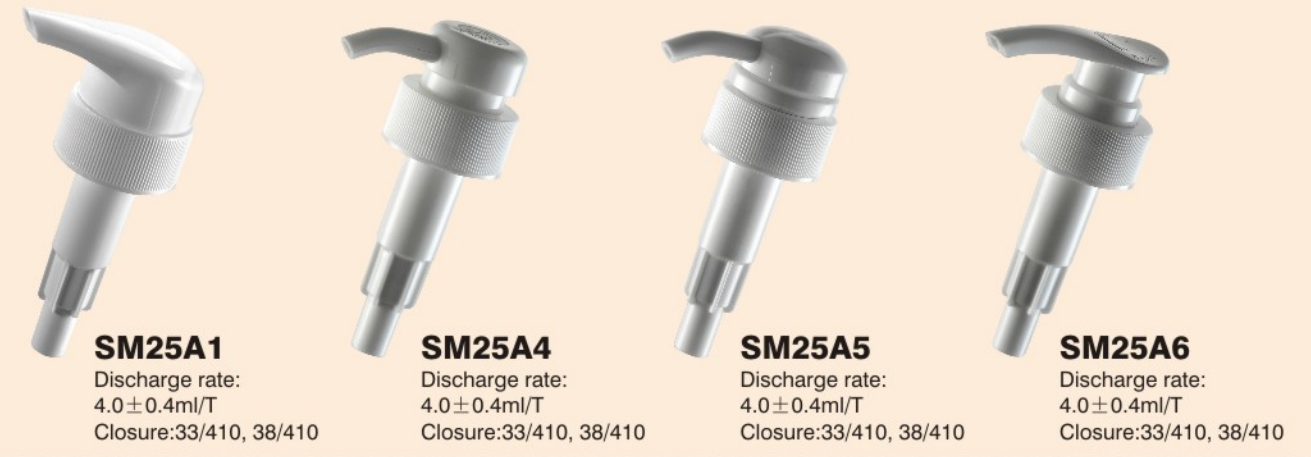

SM25A1
Discharge rate:
4.0±0.4ml/T
Closure:33/410, 38/410

SM25A4
Discharge rate:
4.0±0.4ml/T
Closure:33/410, 38/410

SM25A5
Discharge rate:
4.0±0.4ml/T
Closure:33/410, 38/410

SM25A6
Discharge rate:
4.0±0.4ml/T
Closure:33/410, 38/410



SM25A8
Discharge rate:
4.0±0.4ml/T
Closure:33/410, 38/410

SM25A12
Discharge rate:
4.0±0.4ml/T
Closure:33/410, 38/410

SM25A10
Discharge rate:
4.0±0.4ml/T
Closure:33/410, 38/410

SM25A11
Discharge rate:
4.0±0.4ml/T
Closure:33/410, 38/410

SM25A14
Discharge rate:
4.0±0.4ml/T
Closure:33/410, 38/410

Lotion Pumps / 乳液泵

SM25A series



SM25A15
Discharge rate:
4.0±0.4ml/T
Closure:33/410, 38/410



SM25A16
Discharge rate:4.0±0.4ml/T
Closure:33/410, 38/410



SM25A17
Discharge rate:4.0±0.4ml/T
Closure:33/410, 38/410



SM25A13
Discharge rate:15ml/T
Closure:42mm



SM25A18
Discharge rate:4.0±0.4ml/T
Closure:33/410, 38/410



SM25A19
Discharge rate:4.0±0.4ml/T
Closure:33/410, 38/410



SM25D
Closure:89/410
Capacity:410ml

SM26 series

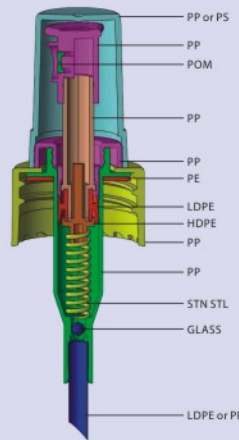

HIGH OUTPUT



SM2601
Discharge rate:
0.8-1.0ml/T
Closure:24/410



SM2602
Discharge rate:
0.8-1.0ml/T
Closure:24/415



SM2603
Discharge rate:
0.8-1.0ml/T
Closure:28/400



SM2604
Discharge rate:
0.8-1.0ml/T
Closure:28/410

SM27 series

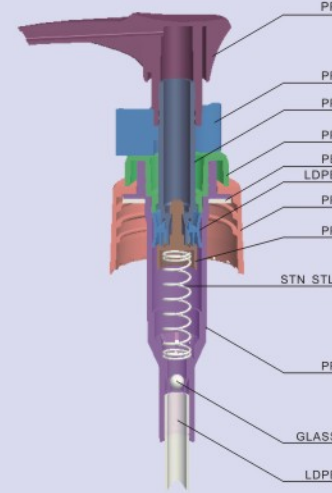

SM27A01
Discharge rate:0.9-1.1ml/T
Closure:20/410
Qty:2000PCS
Meas:57 x 39 x 40cm



SM27A02
Discharge rate:0.9-1.1ml/T
Closure:24/410
Qty:1250PCS
Meas:50 x 38 x 40cm



SM27A03
Discharge rate:0.9-1.1ml/T
Closure:28/410
Qty:1000PCS
Meas:45 x 39 x 50cm

Lock Clip



SM27B01
Discharge rate:0.9-1.1ml/T
Closure:20/410



SM27B02
Discharge rate:0.9-1.1ml/T
Closure:24/410



SM27B03
Discharge rate:0.9-1.1ml/T
Closure:28/410



SM27C01
Discharge rate:0.9-1.1ml/T
Closure:20/410



SM27C02
Discharge rate:0.9-1.1ml/T
Closure:24/410



SM27C03
Discharge rate:0.9-1.1ml/T
Closure:28/410

Bathroom Soap Pumps /卫浴乳液泵

SM25E series

SM25E01 ABS

Finish: GOLD, Chrome, Nickel, Matte, Black Nickel, Ceramic white, Antique Brass, UV Purple
UV Matte, Natural, UV Nickel, Oil Rubbed Bronze, Champagne, Brushed Nickel



Discharge rate:1ml/T
Closure:24/410&28/410
Finish: surface coating

Discharge rate:1ml/T, 2ml/T
Closure:24/410&28/400
Finish: Brushed nickel

Discharge rate:1ml/T,2ml/T
Closure:24/410&28/400
Finish:Champagne

Discharge rate:1ml/T
Closure:24/410&28/400
Finish: UV Purple

SM25E01 Stainless Steel

Finish: Brushed SS, Brushed Nickel, Antique Brass, Oil Rubbed Bronze



Closure:24/410&28/400&28/410
Discharge rate:1ml/T
Finish: Brushed SS

Closure: 24/410&28/400&28/410
Discharge rate:1ml/T
Finish: Brushed SS

Closure: 24/410&28/400&28/410
Discharge rate:1ml/T
Finish: Brushed SS

Closure: 24/410&28/400&28/410
Discharge rate:1ml/T, 2ml/T
Finish: Brushed SS

Closure:24/410&28/400&28/410
Discharge rate:1ml/T
Finish:Oil Rubbed Bronze

Foam Pumps /泡沫泵

SM31 series

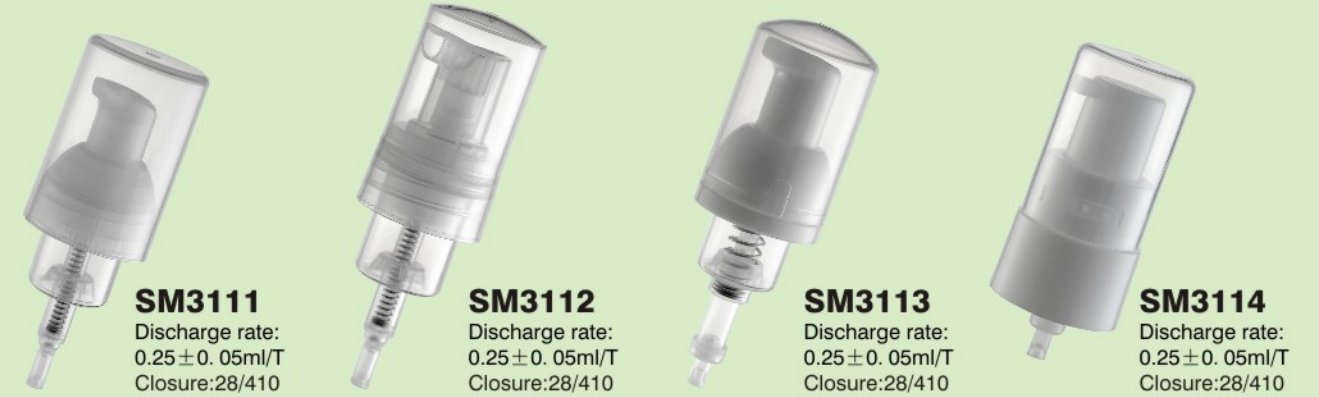

SM3111
Discharge rate:
0.25±0.05ml/T
Closure:28/410

SM3112
Discharge rate:
0.25±0.05ml/T
Closure:28/410

SM3113
Discharge rate:
0.25±0.05ml/T
Closure:28/410

SM3114
Discharge rate:
0.25±0.05ml/T
Closure:28/410



SM3104-A
Discharge rate:
0.4±0.06ml/T
Closure:30mm

SM3104-B
Discharge rate:
0.4±0.06ml/T
Closure:30mm

SM3104-C
Discharge rate:
0.4±0.06ml/T
Closure:30mm

SM3105
Discharge rate:
0.4±0.06ml/T
Closure:30mm

SM3125
Discharge rate:
0.4±0.06ml/T
Closure:30mm



SM3108-A
Discharge rate:
0.8±0.12ml/T
Closure:40mm

SM3108-B
Discharge rate:
0.8±0.12ml/T
Closure:40mm

SM3115
Discharge rate:
0.8±0.12ml/T
Closure:40mm

SM3116
Discharge rate:
0.8±0.12ml/T
Closure:40mm

Foam Pumps / 泡沫泵

SM31 series



SM3117
Discharge rate:
 $0.8 \pm 0.12\text{ml/T}$
Closure:40mm



SM3109
Discharge rate:
 $0.8 \pm 0.12\text{ml/T}$
Closure:43mm



SM3110-A
Discharge rate:
 $0.8 \pm 0.12\text{ml/T}$
Closure:43mm



SM3110-B
Discharge rate:
 $0.8 \pm 0.12\text{ml/T}$
Closure:43mm



SM3119
Discharge rate:
 $0.8 \pm 0.12\text{ml/T}$
Closure:43mm



SM3121
Discharge rate:
 $0.8 \pm 0.12\text{ml/T}$
Closure:43mm



SM3122
Discharge rate:
 $0.8 \pm 0.12\text{ml/T}$
Closure:43mm



SM3124
Discharge rate:
 $0.8 \pm 0.12\text{ml/T}$
Closure:43mm



SM3107
Discharge rate:
 $1.5 \pm 0.22\text{ml/T}$
Closure:40mm



SM3118
Discharge rate:
 $1.5 \pm 0.22\text{ml/T}$
Closure:40mm



SM3120
Discharge rate:
 $1.5 \pm 0.22\text{ml/T}$
Closure:43mm



SM3123
Discharge rate:
 $1.5 \pm 0.22\text{ml/T}$
Closure:43mm



SM3106
Discharge rate:
 1.6ml/T
Closure:40mm

Foam Pump Bottles / 泡沫泵瓶

SM32 series



SM3201
Closure:28mm
Capacity:40ml, 50ml, 80ml



SM3202
Closure:30/410
Capacity:30ml, 50ml, 80ml, 100ml



SM3203
Closure:40/410
Capacity:300ml



SM3204
Closure:43mm
Capacity:100ml, 120ml, 150ml, 200ml, 250ml, 300ml



SM46 series



Fine Mist Sprayers series 喷油小喷雾系列

Oil & Gel Spray for Viscous Products

- Available in a wide range of closures
- Excellent spray pattern
- High variety of inserts
- Compatible with difficult formulations
- It was specially created for aggressive formulas and high-viscosity products.

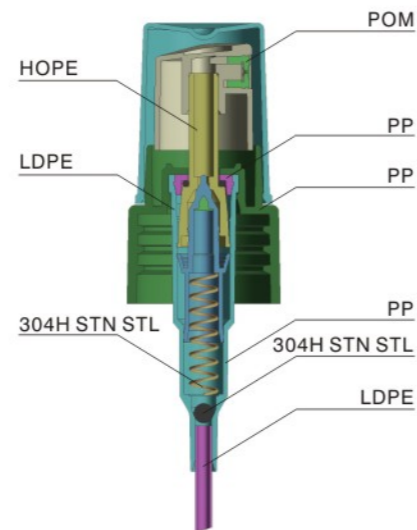

SM46 series



SM4601 Closure:18/410 **SM4602** Closure:18/415 **SM4603** Closure:20/410 **SM4604** Closure:20/410 **SM4605** Closure:22/415



SM4606 Closure:22/415 **SM4607** Closure:24/410 **SM4608** Closure:24/410 **SM4609** Closure:24/415 **SM4610** Closure:24/415

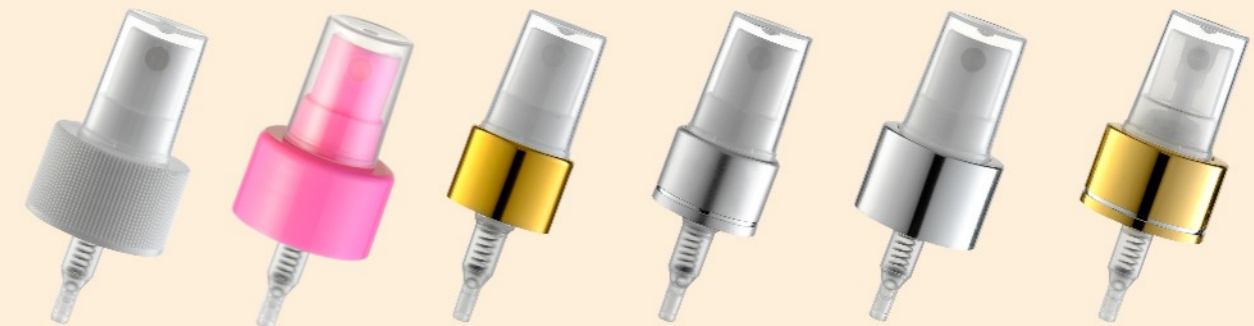

SM4611 Closure:28/410 **SM4612** Closure:28/410 **VARIOUS ALUMINUM SHELL OPTIONS**

Fine Mist Sprayers /小喷雾

SM42 series

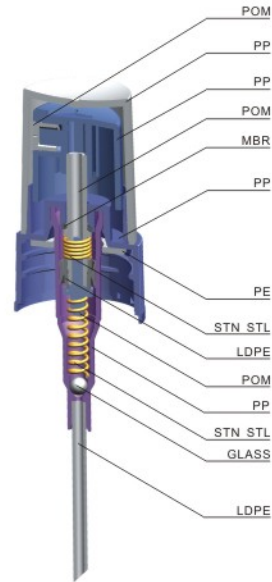

Discharge rate:
0.15-0.18ml/T
Smooth / Ribbed / Aluminum



Round Top Flat Top K Resin Full Cap

- Smooth and ribbed closures in all standard sizes as well as with aluminum shells over the closure.
- Various Aluminum shell options



SM4201 Closure:15/415 **SM4202** Closure:18/410 **SM4203A** Closure:18/415 **SM4203B** Closure:18/415 **SM4204** Closure:20/410 **SM4205** Closure:20/410 **SM4206** Closure:22/415



SM4207 Closure:24/410 **SM4208** Closure:24/410 **SM4209** Closure:24/415 **SM4210** Closure:24/415 **SM4211** Closure:28/410 **SM4212** Closure:28/410

SM45 series



Discharge rate:
0.20-0.30ml/T
Smooth / Ribbed / Aluminum

Discharge rate:
0.12ml/T
Smooth / Ribbed / Aluminum

- Extended side spray available with protective tip covers 20mm-24mm
- Used for drug applications oral sprays and hair care.
- Various Aluminum shell options

EXTENDED SPRAY



SM4501
Discharge rate:0.20-0.30ml/T
Closure:20/410
Closure Options:smooth, ribbed



SM4503
Discharge rate:0.20-0.30ml/T
Closure:24/410



SM4509
Discharge rate:0.20-0.30ml/T
Closure:28/410

VERTICAL SPRAY



SM4505
Discharge rate:0.12ml/T
Closure:18/415



SM4506
Discharge rate:0.12ml/T
Closure:20/400



SM4507
Discharge rate:0.12ml/T
Closure:24/410



SM4508
Discharge rate:0.12ml/T
Closure:18/410, 20/410

ORAL SPRAYER

Fine Mist Sprayers /小喷雾

SM43 series



Discharge rate:
0.20-0.30ml/T
Smooth / Ribbed / Aluminum



Round Top

Flat Top

- Design for low and medium viscosity products
- Usage: Sun care products / Spray Gel / Glitter Spray
- Various Aluminum shell options



SM4303
Spec.:20/410



SM4304
Spec.:20/410



SM4307
Spec.:22/415



SM4314
Spec.:22/415



SM4308
Spec.:24/410



SM4309
Spec.:24/410



SM4310
Spec.:24/415



SM4311
Spec.:24/415



SM4312
Spec.:28/400



SM4315
Spec.:28/400



SM4313
Spec.:28/410



SM4316
Spec.:28/410

SM44 series



Discharge rate:
0.20-0.30ml/T
Smooth / Ribbed / Aluminum

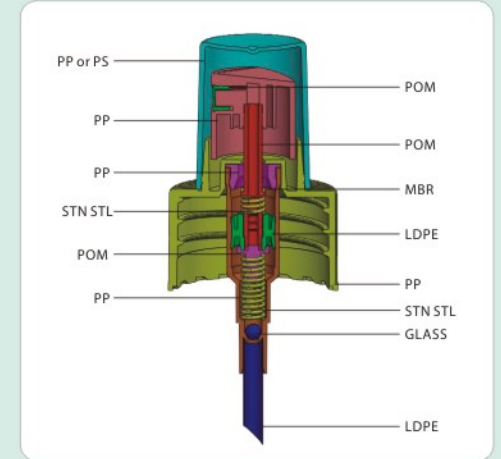

- Designed to spray 360 degrees
- Smooth and ribbed closures in all standard sizes as well as with aluminum shells over the closure
- Best applications are hair and foot care
- Various Aluminum shell options



SM4401
Spec.:20/410



SM4407
Spec.:20/410



SM4402
Spec.:22/415



SM4408
Spec.:22/415



SM4403
Spec.:24/410



SM4309
Spec.:24/410



SM4404
Spec.:24/415



SM4410
Spec.:24/415



SM4411
Spec.:28/400



SM4412
Spec.:28/400



SM4405
Spec.:28/410



SM4406
Spec.:28/410

Fine Mist Sprayers /小喷雾

SM41 series

Discharge rate:
0.05-0.07ml/T



Discharge rate:
0.10-0.14ml/T



SM41 series

Discharge rate:
0.06-0.08ml/T



Aluminum Collars /氧化铝中套

SM78 series



SM78A01 SM78A02 SM78A03 SM78A04 SM78A05 SM78A06



SM78A07 SM78A08 SM78A09 SM78A10 SM78A11 SM78A12

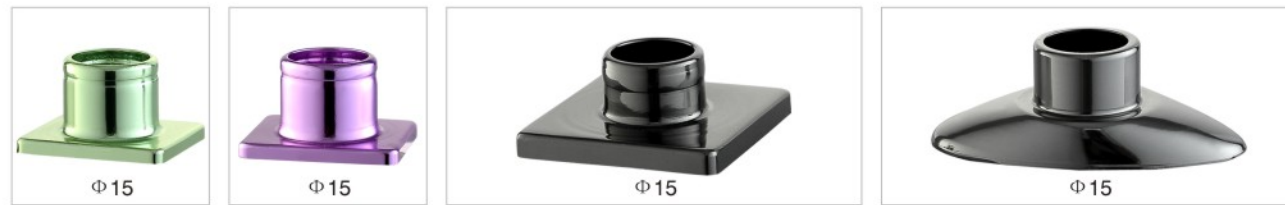

SM78A13 SM78A14 SM78A15 SM78A16



SM78A17 SM78A18 SM78A19 SM78A20



SM78A21 SM78A22 SM78A23 SM78A24 SM78A25

SM78 series



SM78A26 SM78A27 SM78A28 SM78A29 SM78A30



SM78A31 SM78A32 SM78A33 SM78A34 SM78A35

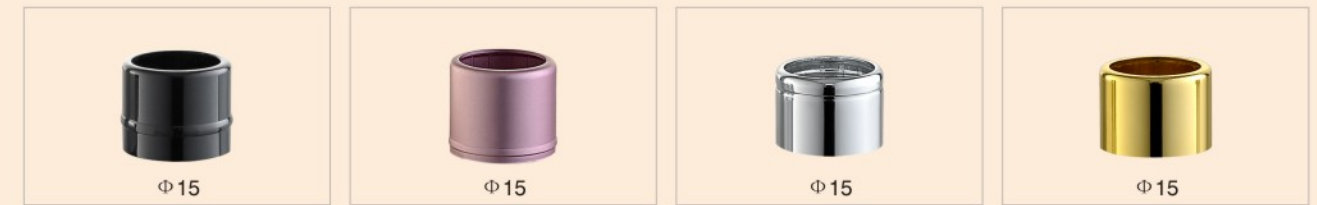

SM78A36 SM78A37 SM78A38 SM78A39



SM78B01 SM78B02 SM78B03 SM78B04 SM78B05



SM78C01 SM78C02 SM78C03 SM78C04

Credit Card Sprayers /卡片瓶

SM52 series

Credit Card Sprayers



10ml
SM5201-10



12ml
SM5201-12A



15ml
SM5201-15
PATENT NO. ZL 2012 3 0429144.0



20ml
SM5201-20A



20ml
SM5201-20B



20ml
SM5201-20C



20ml
SM5201-20D

SM52 series



25ml
SM5201-25A



25ml
SM5201-25B



25ml
SM5201-25C



28ml
SM5201-28A



45ml
SM5201-45A



15ml
SM5203



20ml
SM5204



20ml
SM5205



20ml
SM5206



15ml
SM5207



15ml 10ml
SM5208



15ml 10ml
SM5209



20ml
SM5210

Mini Sprayers /迷你喷雾器

SMS1 series

- 2cc - 30cc mini spray packages standard screw closures dust covers, pop-up spray, pen clip screw finish and snap on sprayers. Credit card shape, dual and trio spray packages.
- These spray components are portable and are designed to carry in pocket or purse.



SMS2 series

Snap on spray with locking actuator

SM5202 30ml

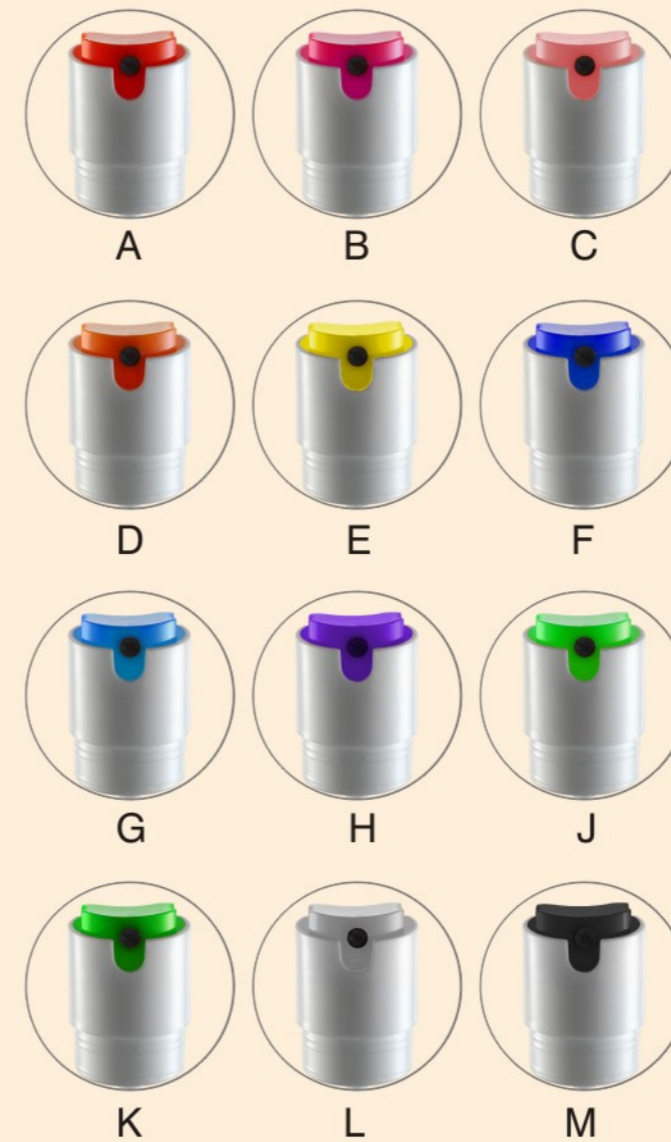

Various color options



Treatment Pumps / 粉泵

SM61 series



MAYPAK PACKAGING
www.maypakcn.com

Treatment Pumps



SM6101 Spec.:22/410 **SM6102** Spec.:24/410 **SM6103** Spec.:22/410 **SM6104** Spec.:24/410 **SM6105** Spec.:22/410 **SM6106** Spec.:24/410



SM6107 Spec.:22/410 **SM6108** Spec.:24/410 **SM6109** Spec.:22/410 **SM6110** Spec.:24/410 **SM6111** Spec.:22/410 **SM6112** Spec.:24/410

SM61 series



SM6113 Spec.:18/410 **SM6114** Spec.:18/410 **SM6115** Spec.:20/410 **SM6116** Spec.:20/410 **SM6117** Spec.:20/410 **SM6119** Spec.:20/410

SM64 series

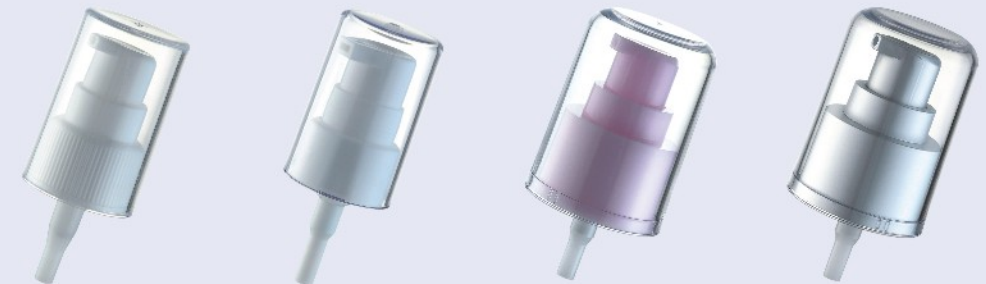

SM6401 Spec.:20/410 Material:PP **SM6402** Spec.:20/410 Material:PP **SM6403** Spec.:24/410 Material:PP **SM6404** Spec.:24/410 Material:UV coating



SM6406 Spec.:24/410 Material:UV coating **SM6407** Spec.:24/410 Material:PP **SM6408** Spec.:24/410 Material:PP **SM6409** Spec.:24/410 Material:Aluminum



Treatment Pumps / 粉泵

SM65 series



SM6501 Spec.:18/415 Material:PP
SM6502 Spec.:18/415 Material:Aluminum
SM6503 Spec.:20/400 Material:Aluminum
SM6504 Spec.:20/410 Material:PP
SM6505 Spec.:24/410 Material:Aluminum

SM62 series



SM6201 Spec.:18/410,18/415
SM6202 Spec.:20/410,20/415
SM6205 Spec.:18/410



SM6206 Spec.:20/410
SM6207 Spec.:18/410
SM6208 Spec.:20/410

Caps / 盖子

SM71 series

Disc Top Caps



Caps / 盖子

SM72 series

Flip Top Caps



SM72 series

Flip Top Caps



Caps / 盖子

SM72 series

Flip Top Caps



Φ28/410

SM7237



Φ24/415

SM7236



Φ24/420

SM7242



Φ32/400

SM7247



Φ20/415

SM7248



Φ28/410

SM7249



Φ28/400

SM7250



Φ38/400

SM7253



Φ24/415

SM7254



Φ20/410, 24/410, 28/410

SM7255

Flip Top caps
MAYPAK PACKAGING
www.maypakcn.com

SM75 series

Other Caps



Φ20/410, 24/410, 28/410

SM7501A



Φ24/415

SM7501B



Φ24/410

SM7505



SM73 series

Screw Caps



Φ15/415

SM7301



Φ18/410

SM7302



Φ20/410

SM7303



Φ24/410

SM7304



Φ18/410

SM7305

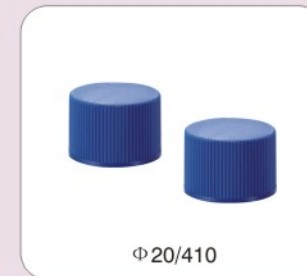

Φ20/410

SM7306



Φ24/410

SM7307



Φ18/410

SM7308



Φ24/410

SM7309



Φ22/415

SM7313



Φ24/415

SM7314



Φ20/415, 24/415

SM7315



Φ22/415

SM7310



Φ28/410

SM7311



Φ53/400

SM7312

Caps / 盖子

SM74 series Push Pull & Twist Caps



MAYPAK PACKAGING
www.maypakcn.com



SM76 series

Perfume Caps series 香水盖系列

Perfume Caps /香水盖
SM76 series

SM76 series



SM7601

SM7602

SM7603

SM7604



SM7605

SM7606

SM7607

SM7608

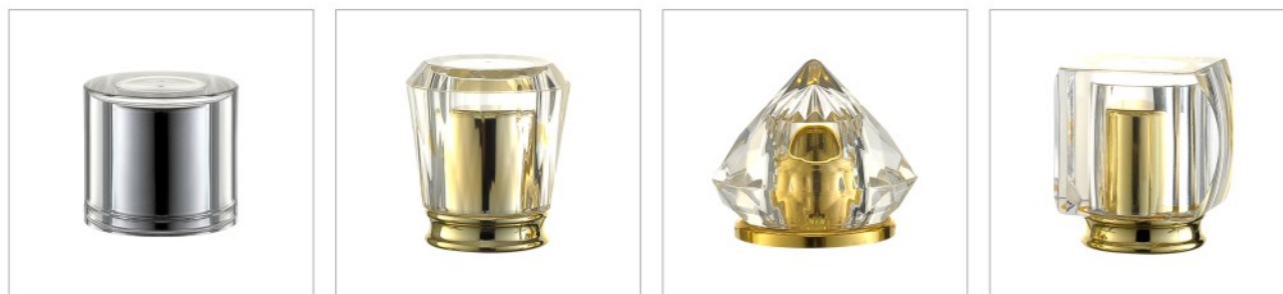

SM7609

SM7610

SM7611

SM7612



SM7614

SM7615

SM7616

SM7617



SM7618

SM7619

SM7620

SM7621

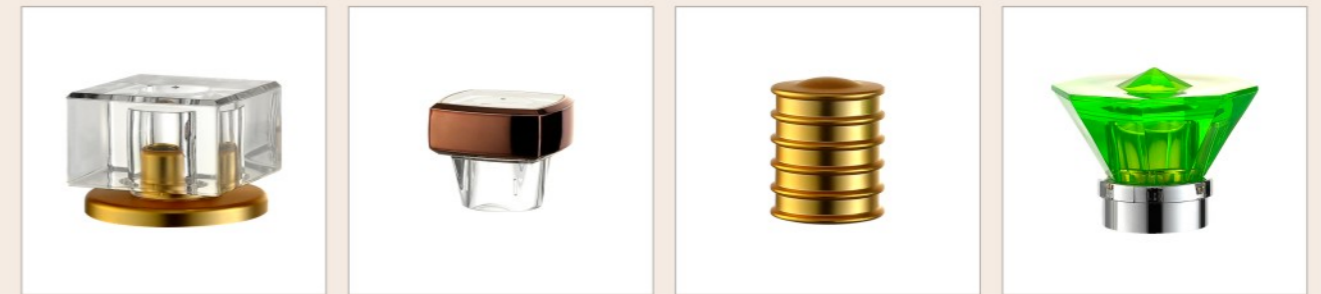

SM7622

SM7623

SM7624

SM7625



SM7626

SM7627

SM7628

SM7629



SM7630

SM7631



Perfume Caps / 香水盖

SM77 series

SM77 series



Ø13mm, 22x29x30.6mm
Ø15mm, 21.55x37.7x35.77mm

SM7702



Ø15mm, 27x36mm

SM7703



Ø15mm, 28.5x37x28mm
Ø15mm, 37x29x30mm

SM7704



Ø15mm, 30x26.5mm

SM7705



Ø15mm, 29x23x29mm

SM7706



Ø15mm, 20.5x22.5x27mm

SM7707



Ø13mm, 22.5x18x28mm
Ø15mm, 27.7x22x29mm

SM7708



Ø15mm, 31x31mm
Ø20mm, 35x32mm

SM7709



Ø15mm, 27x30mm

SM7710



Ø15mm, 27.5x30mm

SM7711



Ø15mm, 27x33mm

SM7712



Ø15mm, 31x29.7mm

SM7713



Ø20/415, 30x30mm

SM7714



Ø15mm, 27.5x30mm

SM7715



Ø15mm, 31x29.7mm

SM7716



Ø18mm, 33.8x30.5mm

SM7718



Ø15mm, 26x30mm

SM7719



Ø13mm, 22x19x33mm

SM7720



Ø13mm, 21x15.8x21.5mm

SM7721

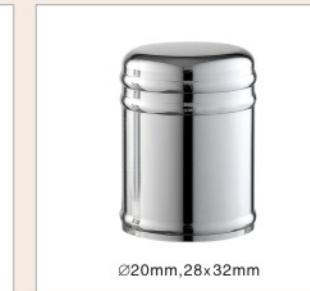

Ø20mm, 28x32mm

SM7723

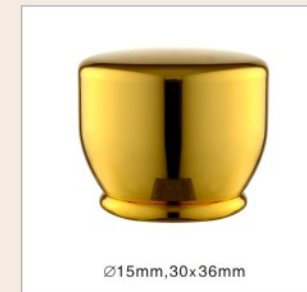

Ø15mm, 30x36mm

SM7724

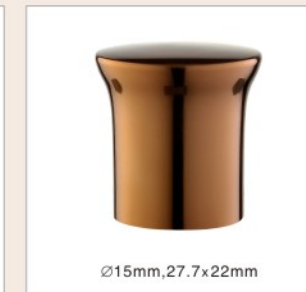

Ø15mm, 27.7x22mm

SM7725

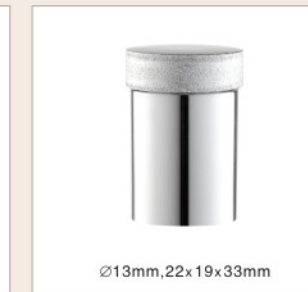

Ø13mm, 22x19x33mm

SM7728



Ø15mm, 31x29.7mm

SM7729



Ø15mm, 26x37mm

SM7730



Ø15mm, 33x24mm

SM7731



Ø15mm, 30x21x29mm

SM7733

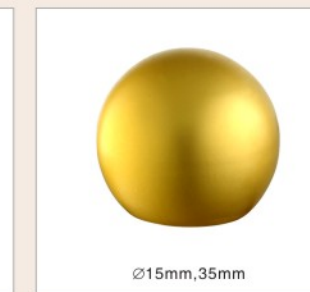

Ø15mm, 35mm

SM7744



Ø20/15mm, 26x30mm

SM7735



Ø15mm, 25.5x30mm

SM7736



Ø15mm, 37x29x30mm

SM7739



Ø20mm, 33.3x32mm

SM7747

Perfume Caps / 香水盖

SM77 series

MP
SERIES

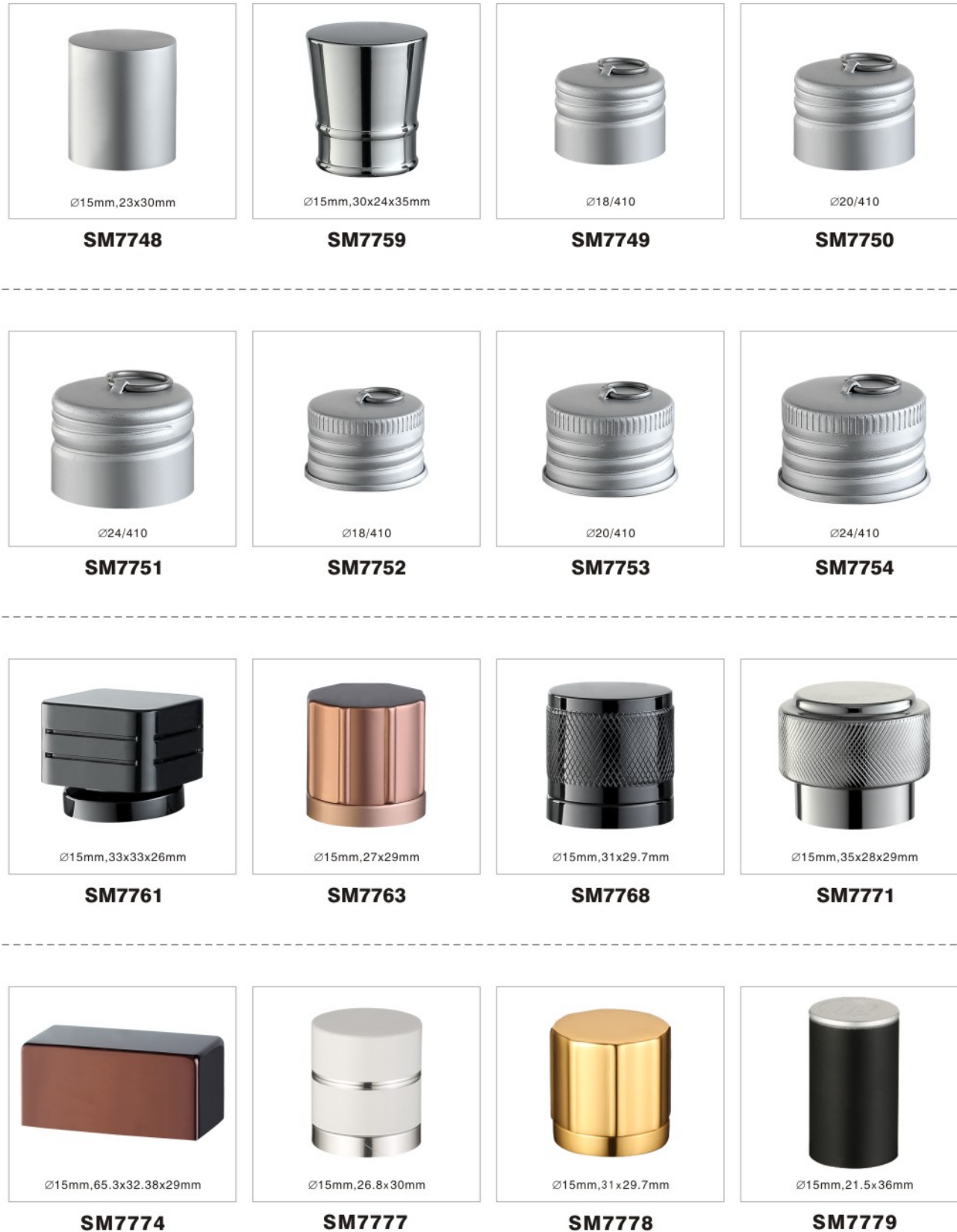

Cosmetic Package

| 化 | 妆 | 品 | 包 | 装 |

Roll on Bottles / 滚珠瓶

MP11 series



MP1106 50ml



MP1109A 30ml



MP1109B 50ml



MP1110 30ml 40ml



MP1111 50ml



MP1112 50ml



MP1113A 30ml



MP1116 75ml



MP1117 75ml

MP11 series



MP1113B 120ml



MP1119 180ml



MP1118 60ml 90ml 120ml



MP1125 50ml



MP1126 50ml



MP1127 70ml



MP1105 45ml



MP1128 50ml



MP1129 50ml

Roll on Bottles / 滚珠瓶

MP11 series



MP1130 60ml



MP1131 75ml



MP1132 50ml

Deodorant Sticks / 膏体管

MP12 series



MP1201 50g



MP1202 90g



MP1203 15g



MP1204 75g



MP1207 30g 50g 75g



MP1208 15g 40g 50g 75g

MP13 series



Powder Spray series

粉瓶系列



Capacity: 14ml/30ml/35ml/70ml/80ml/
110ml/120ml/140ml/180ml

MP53 & 54 series



Acrylic nail polish & Skin essence bottle series 亚克力指甲油瓶/精华液瓶系列

- MP53/54 DECORATION OPTIONS
工艺选择: UV电镀 / 喷涂 / 水转印 / 注塑色
- ① Cap, shoulder & inner bottle hydrographics transfer printed
 - ② Cap & Shoulder UV (metalized), outer bottle internally metalized
 - ③ Cap & Shoulder hydrographics transfer printed

MP53 & 54 series

BOTTLE OPTIONS



MP53 DROPPER OPTIONS

MP54 APPLICATOR OPTONS

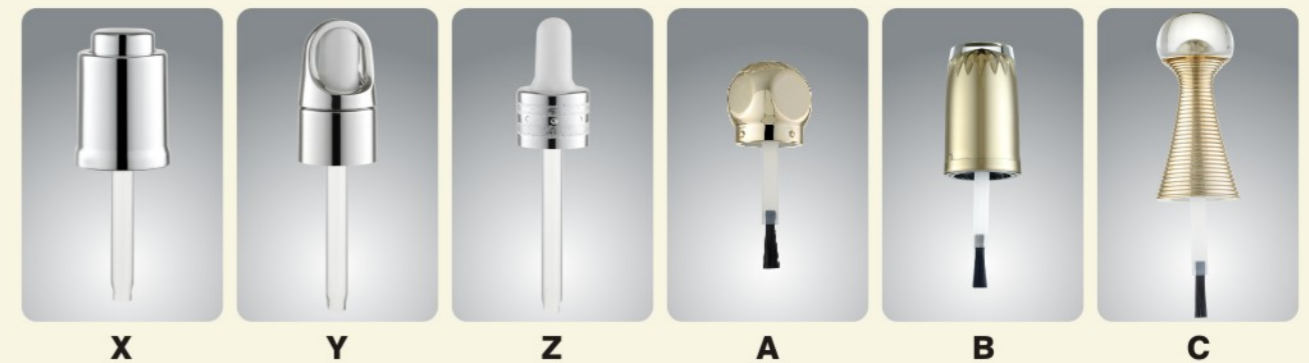

MP54 APPLICATOR OPTONS

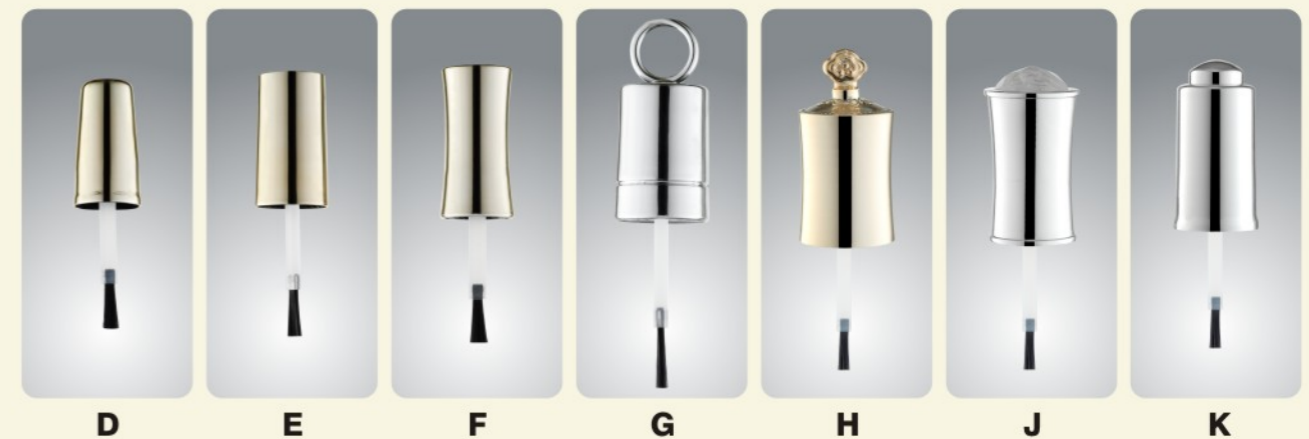

更多内容请登录网站：<http://www.chinaoalglass.com/>
For more information, please visit: <http://www.chinaoalglass.com/>



OPAL GLASS BOTTLES STOCK
& CUSTOM DESIGNS

High Grade White Porcelain Bottle Set series
瓷白瓶系列



Glass Bottles / 玻璃瓶

MP31 series

© Perfume Rod Applicator Samplers

MP3101 (1ml-5ml)



© Dropper Assembly packages with Glass tubes

MP3102 (3ml-30ml)



© Fine Mist sprayers on Tubing glass vials

MP3103 (5ml-50ml)



© Amber and Flint Boston Round Bottles

MP3104



MP31 series



MP3135



MP3136

Glass Bottles /玻璃瓶

MP31 series



MP3105 75ml



MP3106 100ml



MP3107 100ml



MP3108 50ml



MP3109 60ml



MP3111 100ml



MP3113 75ml



MP3116 100ml



MP3126 30ml



MP3130 100ml



MP3131 50ml



MP3133 100ml

MP41 series



PET Acrylic Jars or bottles could be sprayed soft touch frosted and color.

PET & HDPE Bottles series

PET瓶/HDPE瓶系列

PET Bottles /PET瓶

MP41 series

© Preforms

MP4101 (2g-71g)



© Cylinders PET Bottles

MP4102



Standard Cylinders
10ml - 500ml



Squat Cylinders
100ml - 500ml



Tall Cylinders
30ml - 300ml

© Rounds PET Bottles

MP4103



Boston Rounds
15ml - 500ml



Bullet Rounds
15ml - 500ml



Squat Bell Rounds
120ml - 500ml

MP41 series

© Square PET Bottles

MP4104 (20ml-500ml)



© Jars

MP4105 (5g-400g)



© Overcap PET Cylinders

MP4106 (50ml-350ml)



50ml
20/410
D=35mm
H=88mm

100ml
24/410
D=38.6mm
H=122mm

150ml
24/410
D=38.6mm
H=168mm

250ml

350ml

© PET Bottles

MP4111 (29ml)



PET Bottles /PET瓶

MP41 series

Other Shapes PET Bottles © (15ml-1000ml) **MP4108**



©Nail Remover Sets **MP4109**



200ml 200ml 180ml 170ml 150ml

©Travel Sets **MP4110**



A **B** **C** **D**

HDPE Bottles /HDPE瓶

MP42 series

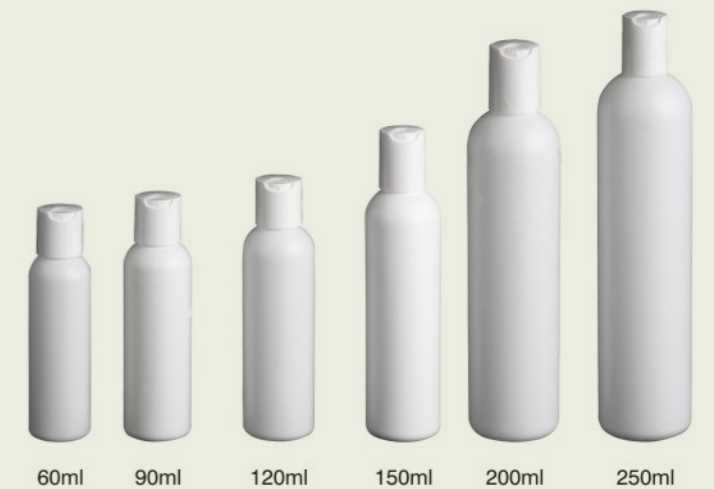

60ml 90ml 120ml 150ml 200ml 250ml

MP4201



50ml 100ml 150ml 200ml 250ml 300ml 350ml 500ml 600ml 1000ml

MP4202

MP4203



Bath Salt series
浴盐系列





Airless & Lotion Bottle series

真空瓶/乳液瓶系列

MP5164



Capacity	H(mm)	D(mm)	Material
15ml	96.0	29.0	PP
30ml	125.0	29.0	
40ml	145.0	29.0	
50ml	161.0	29.0	

MP5165



Capacity	H(mm)	D(mm)	Material
30ml	95.0	37.0	PP
50ml	113.0	37.0	
80ml	146.0	37.0	

MP5166



Capacity	H(mm)	D(mm)	Material
15ml	85.0	35.0	PP
30ml	104.0	35.0	
50ml	129.5	35.0	

MP5167



Capacity	H(mm)	D(mm)	Material
8ml	77.0	25.0	PP
10ml	90.0	25.0	

Airless & Lotion Bottles / 真空瓶 乳液瓶

MP51 series

MP5158



Capacity	P(mm)	H(mm)	D(mm)	Material
30ml	55.0	103.0	35.0	Bottle Body:PP Cap:PP
50ml	80.0	127.0	35.0	



A B C D E

MP5157



Capacity	P(mm)	H(mm)	D(mm)	Material
50ml	50.0	96.15	49.0	Bottle Body:PP Cap:PP
80ml	64.0	99.0	49.0	
100ml	83.5	129.65	49.0	
120ml	96.5	148.6	49.0	
150ml	116.6	162.75	49.0	

MP5101



Capacity	H(mm)	D(mm)	Material
5ml	75.0	19.0	Bottle Body:PP
10ml	105.0	19.0	Cap: PP

MP5102



Capacity	P(mm)	H(mm)	D(mm)	Material
10ml	35.0x77.0	74.7	25.2	Dosage: 1.0cc Material: PP Dosage: 0.25cc
15ml	51.0x77.0	91.0	25.2	
30ml	38.0x92.0	119.0	30.2	
50ml	70.0x114.0	116.7	36.3	

MP5103



Capacity	P(mm)	H(mm)	D(mm)	Material
7.5ml	66.0	115.0	23.0	Bottle Body:AS Cap:AS Inner Bottle:PP
10ml	80.0	156.0	23.0	
15ml	106.0	155.0	23.0	

MP5104



Capacity	P(mm)	H(mm)	D(mm)	Material
15ml	45.0	88.0	31.0	Bottle Body:PP Round/Square Cap:PP
30ml	74.0	118.0	31.0	

Airless & Lotion Bottles / 真空瓶 乳液瓶

MP51 series

MP5105



Capacity	P(mm)	H(mm)	D(mm)	Material
30ml	63.0	107.0	45.0x31.0	Bottle Body:PP
50ml	83.0	127.0	45.0x31.0	Cap:PP

MP5107



Capacity	H(mm)	D(mm)	Material
20ml	100.0	33.0	Bottle Body:PP
30ml	111.0	33.0	Cap:PP
50ml	140.0	33.0	Inner Bottle:PP

MP5109



Capacity	P(mm)	H(mm)	D(mm)	Material
6ml	44.0	77.0	19.0	Bottle Body:AS Cap:PP
10ml	64.0	98.0	19.0	
12ml	79.0	112.0	19.0	

MP5111



Capacity	P(mm)	H(mm)	D(mm)	Material
15ml	28.0	94.0	34.0	Bottle Body:AS Cap:PP
30ml	47.0	113.0	34.0	
50ml	78.0	143.0	34.0	

MP5108



Capacity	P(mm)	H(mm)	D(mm)	Material
30ml	47.0	82.0	45.0	Bottle Body:PP Cap:PP
50ml	64.0	99.0	45.0	
80ml	87.0	121.0	45.0	
100ml	104.0	138.0	45.0	
120ml	115.0	150.0	45.0	
135ml	131.0	165.0	45.0	
150ml	148.0	182.0	45.0	
200ml	183.0	217.0	45.0	

MP5115



Capacity	P(mm)	H(mm)	D(mm)	Material
15ml	81.0x36.0	112.0	30.0	Dosage:0.25cc
20ml	81.0x50.0	126.0	30.0	Material:
30ml	81.0x85.0	160.0	30.0	SAN
50ml	81.0x100.0	174.0	30.0	ABS

MP5116



Capacity	P(mm)	H(mm)	D(mm)	Material
30ml	65.0	133.0	53.0x46.0	Bottle BODY:AS Cap:AS Inner Bottle:PP
50ml	102.0	170.0	53.0x46.0	

Airless&Lotion Bottles /真空瓶 乳液瓶

MP51 series

MP5118



Capacity	P(mm)	H(mm)	D(mm)	Material
15ml	83.0	98.0	40.0	Bottle Body:AS
30ml	115.0	130.0	40.0	Cap:ABS
40ml	133.0	148.0	40.0	Inner Bottle:PP
50ml	149.0	164.0	40.0	

MP5120



Capacity	P(mm)	H(mm)	D(mm)	Material
30ml	113.0	127.0	38.0x53.0	Bottle Body:AS
40ml	125.0	139.0	38.0x53.0	Cap:ABS Inner Bottle:PP

MP5147



Capacity	H(mm)	D(mm)	Material
40ml	117.0	38.0	
60ml	154.0	38.0	
80ml	138.0	45.0	
120ml	179.0	45.0	

Capacity	H(mm)	D(mm)	Material
10g	35.9	56.0	PMMA-OUTER
15g	44.0	67.0	PP-INNER
30g	48.0	67.0	ABS
50g	53.0	76.0	

MP5119



Capacity	P(mm)	H(mm)	D(mm)	Material
15ml	118.0	101.0	37.0x37.0	Bottle Body:AS
30ml	126.0	130.0	37.0x37.0	Cap:ABS
50ml	126.0	166.0	37.0x37.0	Inner Bottle:PP

Capacity	H(mm)	D(mm)	Material
15g	33.0	58.0x58.0	PMMA-OUTER JAR
30g	38.0	58.0x58.0	PP-INNER BOTTLE
50g	51.0	68.0x68.0	ABS/LDPE

MP5122



Capacity	P(mm)	H(mm)	D(mm)	Material
15ml	106.0x55.0	101.0	44.0	Dosage:0.25cc Material:ABS
30ml	117.0x70.0	131.0	48.5	PMMA-Outer Bottle
60ml	117.0x90.0	155.0	48.5	PET-Inner Bottle

Capacity	H(mm)	D(mm)	Material
30g	55.0	62.0	ACRYLIC
50g	62.0	69.0	PP, PE, ABS

Airless&Lotion Bottles /真空瓶 乳液瓶

MP51 series

MP5125



Capacity	P (mm)	H (mm)	D (mm)	Material
15ml	20.0x15.0	86.0	40.0x31.0	Dosage:0.25cc
30ml	20.0x40.0	110.0	40.0x31.0	Material: SAN-Outer Bottle PET-Inner Bottle
50ml	20.0x65.0	140.0	40.0x31.0	

MP5126



Capacity	P (mm)	H (mm)	D (mm)	Material
40ml	68.0	128.0	37.0	Bottle Body:AS
60ml	105.0	165.0	37.0	Cap:AS Inner Bottle:HDPE

MP5131



Capacity	P (mm)	H (mm)	D (mm)	Material
50ml	62.0	108.0	51.0	AS/PP
80ml	84.0	132.0	51.0	
120ml	112.0	160.0	51.0	
150ml	146.0	193.0	51.0	

Capacity	H (mm)	D (mm)	Material
15g	59.0	55.0	ACRYLIC/PP/ABS
30g	70.0	55.0	
50g	74.0	63.0	

MP5128



Capacity	P (mm)	H (mm)	D (mm)	Material
15ml	57.0	91.0	37.0	Bottle Body:AS
30ml	85.0	119.0	37.0	Cap:AS
50ml	122.0	156.0	37.0	Inner Bottle:PP

MP5152



Capacity	P (mm)	H (mm)	D (mm)	Application
15ml	42.0	95.5	36.8	0.23ml
30ml	70.0	123.6	36.8	0.23ml
50ml	97.0	151.9	36.8	0.23ml

MP5138



Capacity	P (mm)	H (mm)	D (mm)	Material
15ml	15/20x40	111.0	33.0x32.0	Dosage:0.25cc
30ml	15/20x75	160.0	35.0x32.0	Material:ABS
60ml	25/30x75	165.0	49.0x43.0	PMMA-Outer Bottle
120ml	30/35x90	180.0	61.0x51.0	PET-Inner Bottle

Capacity	P (mm)	H (mm)	D (mm)	Material
5g	20/23x8	24.0	33.0x35.0	PMMA-OUTER
15g	37/39x12	43.0	68.0x62.0	PP-INNER
30g	37/39x12	50.0	68.0x62.0	LDPE
50g	47/49x22	55.0	75.0x70.0	

Airless&Lotion Bottles /真空瓶 乳液瓶

MP51 series

MP5134



Capacity	H _(mm)	D _(mm)	Material
15ml	105.0	36.0	Bottle Body:AS
30ml	131.0	36.0	Cap:AS
50ml	154.0	36.0	

MP5135



Capacity	P _(mm)	H _(mm)	D _(mm)	Material
15ml	26.0	89.0	31.0	Bottle Body:AS
20ml	36.0	99.0	31.0	Cap:AS
30ml	56.0	119.0	31.0	



MP5139

Capacity	P _(mm)	H _(mm)	D _(mm)	Material
15ml	95.0x40.0	110.0	37.0x32.0	Dosage:0.25cc
30ml	95.0x80.0	162.0	37.0x32.0	Material:ABS
60ml	125.0x80.0	162.0	49.0x40.0	PMMA-Outer Bottle
120ml	150.0x100.0	181.0	61.0x49.0	PET-Inner Bottle

Capacity	P _(mm)	H _(mm)	D _(mm)	Material
5g	102.0x11.0	25.0	33.0	PMMA-OUTER PP-INNER
15g	195.0x13.0	40.0	63.0	
30g	195.0x20.0	48.0	63.0	
50g	220.0x25.0	52.0	71.0	
100g	285.0x28.0	61.0	92.0	

MP5137



Capacity	P _(mm)	H _(mm)	D _(mm)	Material
90ml	84.0	135.0	51.0	Bottle Body:AS
130ml	112.0	163.0	51.0	Cap:AS Inner Bottle:HDPE

MP5145



Capacity	H _(mm)	D _(mm)	Material
15ml	115.0	32.0	Acrylic,ABS,PP
A-30ml	142.0	32.0	
B-30ml	131.0	38.0	
50ml	153.0	38.0	
100ml	184.0	42.0	
120ml	182.0	47.0	

MP5140



Capacity	P _(mm)	H _(mm)	D _(mm)	Material
15ml	105.0x20.0	92.0	33.5	Dosage:0.25cc
30ml	105.0x40.0	115.0	33.5	Material:
50ml	105.0x70.0	145.5	33.5	SAN
60ml	105.0x88.0	174.0	33.5	ALUMINUM

Capacity	P _(mm)	H _(mm)	D _(mm)	Material
80ml	125.0x70.0	158.0	41.0	Dosage:0.25cc
100ml	125.0x90.0	180.0	41.0	Material:
120ml	125.0x110.0	200.0	41.0	SAN ALUMINUM

Airless&Lotion Bottles /真空瓶 乳液瓶

MP51 series

Capacity	P (mm)	H (mm)	D (mm)	Material
15ml	80.0x370.0	110.0	27.5	Dosage:0.25cc Material: SAN ALUMINUM
30ml	105.0x400.0	124.0	33.5	
50ml	105.0x700.0	155.0	33.5	
80ml	125.0x700.0	154.0	41.0	
100ml	125.0x900.0	175.0	41.0	
120ml	125.0x1100.0	195.0	41.0	

MP5141



MP5142

Capacity	P (mm)	H (mm)	D (mm)	Material
50ml	98.0	157.0	46.0	Bottle Body:MS Cap: ABS Inner Bottle: PP
100ml	117.0	176.0	53.0	

Capacity	P (mm)	H (mm)	D (mm)	Material
10g	21.0	42.0	50.0	Bottle Body:MS Cap: ABS Inner Bottle: PP
50g	27.0	65.0	73.0	

Capacity	P (mm)	H (mm)	D (mm)	Material
2g	108.0x9.0	29.0	35.0	PMMA-OUTER PP-INNER LDPE
5g	108.0x9.0	29.0	35.0	
10g	145.0x11.0	32.7	47.0	
15g	170.0x17.0	38.0	60.0	
30g	195.0x20.0	44.0	60.0	
50g	220.0x25.0	51.0	72.0	
100g	260.0x30.0	59.0	90.0	
150g	290.0x35.0	70.0	90.0	
200g	290.0x45.0	87.0	90.0	

MP6110



MP5143

Capacity	P (mm)	H (mm)	D (mm)	Material
50ml	99.0	169.0	46.0	BOTTLE BODY :MS CAP:ABS INNER BOTTLE:PP
100ml	117.0	187.0	53.0	

Capacity	P (mm)	H (mm)	D (mm)	Material
10g	22.0	43.0	50.0	BOTTLE BODY :MS CAP:ABS INNER BOTTLE:PP
50g	29.0	68.0	73.0	

Airless&Lotion Bottles /真空瓶 乳液瓶

MPS1 series



MP5161

Capacity	P(mm)	H(mm)	D(mm)	Material
50ml	99.0	158.0	46.0	Bottle Body:MS,PETG Cap: ABS Inner Bottle: PP
100ml	117.0	177.0	53.0	

Capacity	P(mm)	H(mm)	D(mm)	Material
10g	22.0	40.0	50.0	Bottle Body:MS,PETG Cap: ABS Inner Bottle: PP
50g	29.0	60.0	73.0	



MP5146

Capacity	H(mm)	D(mm)	Material
15ml	109.5	37.0	PMMA, ABS, PP
30ml	140.0	37.0	
50ml	174.0	37.0	
100ml	198.5	42.0	

Capacity	H(mm)	D(mm)	Material
5g	37.0	37.0	PMMA, PP, PE
10g	44.0	44.0	
15g	54.0	54.0	
30g	56.0	56.0	
50g	62.0	62.0	



MP5144

Capacity	P(mm)	H(mm)	D(mm)	Material
30ml	81.0	175.0	37.0	Bottle Body:AS CAP:MS Inner Bottle:PP



MP5163

Capacity	P(mm)	H(mm)	D(mm)	Material
38ml	80.0	120.0	32.0x58.0	NS



MP5149

Capacity	H(mm)	D(mm)	Material
15ml	95.0	35.0x35.0	PMMA-OUTER JAR
20ml	114.0	34.0x34.0	PP-INNER BOTTLE
30ml	122.0	35.0x35.0	ABS
50ml	147.0	35.0x35.0	LDPE
100ml	174.0	43.0x43.0	LDPE
120ml	192.0	47.0x47.0	
140ml	192.0	47.0x47.0	

Capacity	P(mm)	H(mm)	D(mm)	Material
5g	25.0x8.0	33.0	40.0x40.0	PMMA-OUTER JAR
10g	35.0x12.0	36.0	46.0x46.0	PP-INNER BOTTLE
15g	40.0x15.0	40.0	60.0x60.0	ABS
30g	45.0x17.0	44.0	60.0x60.0	LDPE
50g	50.0x20.0	48.0	68.0x68.0	

Airless & Lotion Bottles / 真空瓶 乳液瓶

MP51 series

MP5153



Capacity	H(mm)	D(mm)	Material
15ml	87.0	40.0	ABS, PP, PMMA
30ml	112.0	40.0	
50ml	145.0	40.0	

MP5154



Capacity	H(mm)	D(mm)	Material
30ml	97.6	49.2	MS, ABS, PP
50ml	114.6	49.2	
80ml	141.6	49.2	

MP5159



Capacity	H(mm)	D(mm)	Material
15ml	115.0	32.0	Acrylic, ABS, PP
A-30ml	142.0	32.0	
B-30ml	131.0	38.0	
50ml	153.0	38.0	
80ml	184.0	42.0	
100ml	184.0	42.0	
120ml	182.0	47.0	

MP5162



Capacity	P(mm)	H(mm)	D(mm)	Material
20mlx2	68.0	128.0	37.0	AS, HDPE
30mlx2	105.0	165.0	37.0	

MP5155



Capacity	H(mm)	D(mm)	Material
30ml	93.5	42.5	ABS, PP
50ml	118.0	42.5	ACRYLIC

MP5156



Capacity	P(mm)	H(mm)	D(mm)	Material
25ml	49.0	107.0	39.0	MS
50ml	97.0	155.0	39.0	

MP5177



Capacity	H(mm)	D(mm)	Material
10g	163.0	20.0	PETG, PP, AS
20g	172.0	23.5	

MP5168



Capacity	H(mm)	D(mm)	Material
60ml	125.0	48.0	PP
100ml	170.0	47.0	
120ml	182.0	46.0	

Airless&Lotion Bottles /真空瓶 乳液瓶

MPS1 series



MP5160

Capacity	H(mm)	D(mm)	Material
15ml	105.0	39.0	ACRYLIC, ABS, PP
30ml	131.0	39.0	

Capacity	H(mm)	D(mm)	Material
15g	45.5	50.0	ACRYLIC, ABS, PP
30g	48.0	62.4	
50g	53.0	68.0	



MP5170

Capacity	H(mm)	D(mm)	Material
30ml	118.0	43.0x37.0	ACRYLIC, PPABS
50ml	142.0	43.0x37.0	
100ml	186.0	46.0x40.0	

Capacity	H(mm)	D(mm)	Material
20g	46.0	62.0x55.0	ACRYLIC, PPABS
30g	46.0	62.0x55.0	
50g	54.0	65.0x59.0	



MP5169

Capacity	H(mm)	D(mm)	Material
20ml	129.0	43.0	ACRYLIC, ABS, PP
50ml	172.0	43.0	
100ml	189.0	52.0	

Capacity	H(mm)	D(mm)	Material
15g	43.0	61.0	ACRYLIC, ABS, PP
30g	53.0	64.0	
50g	66.0	71.0	



MP5171

Capacity	H(mm)	D(mm)	Material
30ml	130.0	49.0	ACRYLIC, ABS, PP
50ml	140.0	49.0	
120ml	190.0	49.0	

Capacity	H(mm)	D(mm)	Material
30g	53.0	78.0	ACRYLIC, ABS, PP
50g	63.0	78.0	
120g	76.0	98.0	

Airless&Lotion Bottles /真空瓶 乳液瓶

MP51 series



MP5172

Capacity	H(mm)	D(mm)	Material
15ml	114.2	33.0	PMMA/PETG/ABS
30ml	132.4	33.0	
50ml	174.9	33.0	
80ml	186.9	36.3	
120ml	197.8	44.8	

Capacity	H(mm)	D(mm)	Material
15g	43.7	61.0	PMMA/PP
30g	48.4	61.0	
50g	53.0	68.0	



MP5178

Capacity	P(mm)	H(mm)	D(mm)	Material
40ml	41.0	99.0	48.0	Bottle body:AS Cap:NS
60ml	55.0	114.0	48.0	
130ml	106.0	164.0	48.0	



MP5173

Capacity	H(mm)	D(mm)	Material
30g	156.0	32.0x43.0	Acrylic,PP
40g	156.0	32.0x43.0	
50g	156.0	32.0x43.0	



MP5179

Capacity	H(mm)	D(mm)	Material
15ml	105.7	36.5	PP/ABS
30ml	121.4	41.0	
50ml	153.9	43.9	
120ml	160.2	53.5	

Capacity	H(mm)	D(mm)	Material
30g	61.7	56.5	PP/ABS
50g	78.0	69.0	



MP5174

Capacity	H(mm)	D(mm)	Material
30g	154.0	32.0x43.0	Acrylic,PP
40g	154.0	32.0x43.0	
50g	154.0	32.0x43.0	



MP5175

Capacity	H(mm)	D(mm)	Material
30g	122.0	45.0x30.0	Acrylic,PP
50g	152.0	45.0x30.0	

Cream Jars / 膏霜瓶

MP61 series

MP6105A



Capacity	P(mm)	H(mm)	D(mm)	Material
15g	P:162x8 P1:162x8 P2:37.8	51.1	55.7	PMMA-OUTER
30g	P:194x9 P1:194x9 P2:46.3	61.1	67.0	PP-INNER
50g	P:218x11 P1:218x11 P2:54	71.5	75.0	LDPE

MP6105B



Capacity	H(mm)	D(mm)	Material
15g	52.0	56.0	PMMA-OUTER
30g	61.0	65.0	PP-INNER
50g	70.0	74.0	LDPE

MP6115



Capacity	P(mm)	H(mm)	D(mm)	Material
15g	10.0x137.0	31.5	44.3	PETG
30g	14.0x158.0	36.0	51.0	
50g	20.0x174.0	43.0	56.3	
100g	22.0x228.0	47.0	74.0	

MP6112



Capacity	H(mm)	D(mm)	Material
30g	81.0	60.0	MS
50g	90.0	70.0	PP

MP6113



Capacity	H(mm)	D(mm)	Material
15g	42.0	53.0	ACRYLIC, PP, PE
30g	54.0	61.0	
50g	62.0	70.0	

MP6119



Capacity	H(mm)	D(mm)	Material
15g	43.5	57.0X57.0	ACRYLIC, PP, PE
30g	46.0	64.5X64.5	
50g	54.0	74.0X74.0	

MP6121



Capacity	H(mm)	D(mm)	Material
30g	43.0	60.0	ACRYLIC, PP
50g	54.0	70.0	
150g	72.0	92.0	
200g	87.0	92.0	

MP6122



Capacity	H(mm)	D(mm)	Material
15g	38.5	67.0	ACRYLIC, PP, PE
30g	44.5	78.0	
50g	51.0	91.0	

Cream Jars / 膏霜瓶

MP62 series



Capacity	H(mm)	D(mm)	Material
20ml	82.8	29.0x18.3	PP
50ml	120.6	42.5x23.8	
100ml	144.2	53.4x27.4	
200ml	177.4	65.2x36.0	
300ml	163.0	66.5x45.0	
400ml	215.8	77.4x43.4	

Capacity	H(mm)	D(mm)	Main Material
20g	43.8	58.6x58.6	PP
50g	48.7	68.0x68.0	



Capacity	H(mm)	D(mm)	Material
10g	38.0	51.0	PP
25g	42.0	65.0	
30g	43.0	53.0	
50g	44.0/48.0	48.0/58.0	
60g	57.0/60.0	60.0/65.0	
80g	50.0	58.0	

Capacity	H(mm)	D(mm)	Material
100g	60.0	65.0	PP
120g	58.0/70.0	76.0/72.5	
200g	63.0	85.0	
300g	159.0	73.0	
400g	159.0	73.0	
500g	102.0/200.0	98.5/73.0	

MP6209



Capacity	P(mm)	H(mm)	D(mm)	Material
50g	35x55	51.0	55.0	PP

MP6210



Capacity	P(mm)	H(mm)	D(mm)	Material
15g	21.2x51	33.8	51.0	PP

MP6207



Capacity	H(mm)	D(mm)	Main Material
5g	43.8	58.6x58.6	PP

MP6216



Capacity	H(mm)	D(mm)	Main Material
50g	41.0	57.0	PP
100g	54.0	71.0	
150g	54.0	78.0	

Cream Jars / 膏霜瓶

MP62 series

MP6213



Capacity	H(mm)	D(mm)	Material
5g	24.9	34.9	PP
30g	39.5	52.9	
40g	44.5	52.9	
50g	41.6	63.7	
60g	45.6	63.7	
100g	50.4	74.5	

Capacity	H(mm)	D(mm)	Material
120g	55.8	74.5	PP
150g	64.1	74.5	
200g	62.9	89.6	
250g	71.3	89.6	
500g	87.0	110.0	

MP6214



Capacity	H(mm)	D(mm)	Material
5g	24.0	33.0	PP
10g	29.0	40.5	
20g	33.0	48.0	
30g	40.0	52.0	
50g	49.0	59.0	
80g	55.0	67.0	

MP6215



Capacity	H(mm)	D(mm)	Material
50g	60.0	59.5	PP
150g	70.0	81.0	
250g	79.5	92.5	

MP6217



Capacity	H(mm)	D(mm)	Material
120g	52.3	70.6	PP
200g	51.0	91.4	
240g	51.7	91.6	
300g	70.0	91.8	
500g	82.4	103.0	

MP6212



Capacity	H(mm)	D(mm)	Main Material
100g	50.8	67.2	PP

MP6218



Capacity	H(mm)	D(mm)	Material
100g	50.5	77.0	PP
160g	50.5	93.0	
200g	50.5	103.0	



Aluminum Bottle & Jar series
铝瓶/铝罐系列



MP7100 MP7101 MP7102 MP7103 MP7104 MP7105 MP7106 MP7107



MP7108 MP7109 MP7110 MP7111 MP7112 MP7113 MP7114

Item	Capacity(ml)	Mouth dia(mm)	Bottle dia(mm)	Bottle height(mm)	Pcs/ctn(pcs)	Ctn size(cm)
MP7100	30	Ø20	32	76	400	35x35x36
MP7101	50	Ø24	36	83	200	39x39x20
MP7102	65	Ø24	36	94	200	39x39x22
MP7103	80	Ø24	36	106	200	39.5x39.5x24
MP7104	100	Ø24	40	110	200	44x44x25
MP7105	120	Ø24	45	115	200	49x49x26
MP7106	150	Ø24	45	143	200	49x49x31
MP7107	200	Ø24	50	150	200	54x54x33
MP7108	250	Ø24/28	50	174	200	54x54x37
MP7109	300	Ø24/28	50	190	200	54x54x40
MP7110	350	Ø24	59	160	120	61.5x37x35
MP7111	250	Ø24/28	73	104	96	62x47x24
MP7112	400	Ø24/28	73	135	48	62x47x17
MP7113	500	Ø24/28	73	160	48	63x47.5x19
MP7114	750	Ø24/28	73	226	48	63x47.5x25

Alu. Bottles & Jars / 铝瓶 铝罐

MP72 series



MP7201
15g/20g/25g/30g/40g/50g/60g/75g/80g/100g/200g/150g/250g/350g



MP7202
60g/80g/100g/150g

MP73 series



MP73

Item	Capacity(ml)	Mouth dia(mm)	Bottle height(mm)
MP7301	30	Ø45	60
MP7302	50	Ø45	70
MP7303	65	Ø45	80
MP7304	100	Ø45	110
MP7305	150	Ø45	140
MP7306	200	Ø50	150
MP7307	250	Ø50	170
MP7308	300	Ø50	190
MP7309	350	Ø59	160
MP7310	500	Ø73	180
MP7311	1000	Ø88	230
MP7312	1250	Ø88	255

Air Cushion Compacts / 气垫BB霜

MP111 series



MP11101 15g

MP11103 15g

MP11102 15g

Lipsticks / 口红管

MP112 series



MP11201
Size:Ø16x67mm
Cup size:Ø12.1mm

MP11202
Size:Ø16x69mm
Cup size:Ø12.1mm

MP11203
Size:Ø22.6x92mm

MP11204
Size:Ø19.6x61mm
Cup size:Ø12.1/12.7mm

MP11205
Size:Ø19.5x66.9mm
Cup size:Ø12.1/12.7mm



MP11206
Size:Ø21x75mm
Cup size:Ø12.1/12.7mm



MP11207
Size:Ø19x72mm
Cup size:Ø12.1/12.7mm



MP11208
Size:Ø20.3x65.2mm
Cup size:Ø12.1/12.7mm



MP11209
Size:Ø20.3x65.2mm
Cup size:Ø12.1/12.7mm

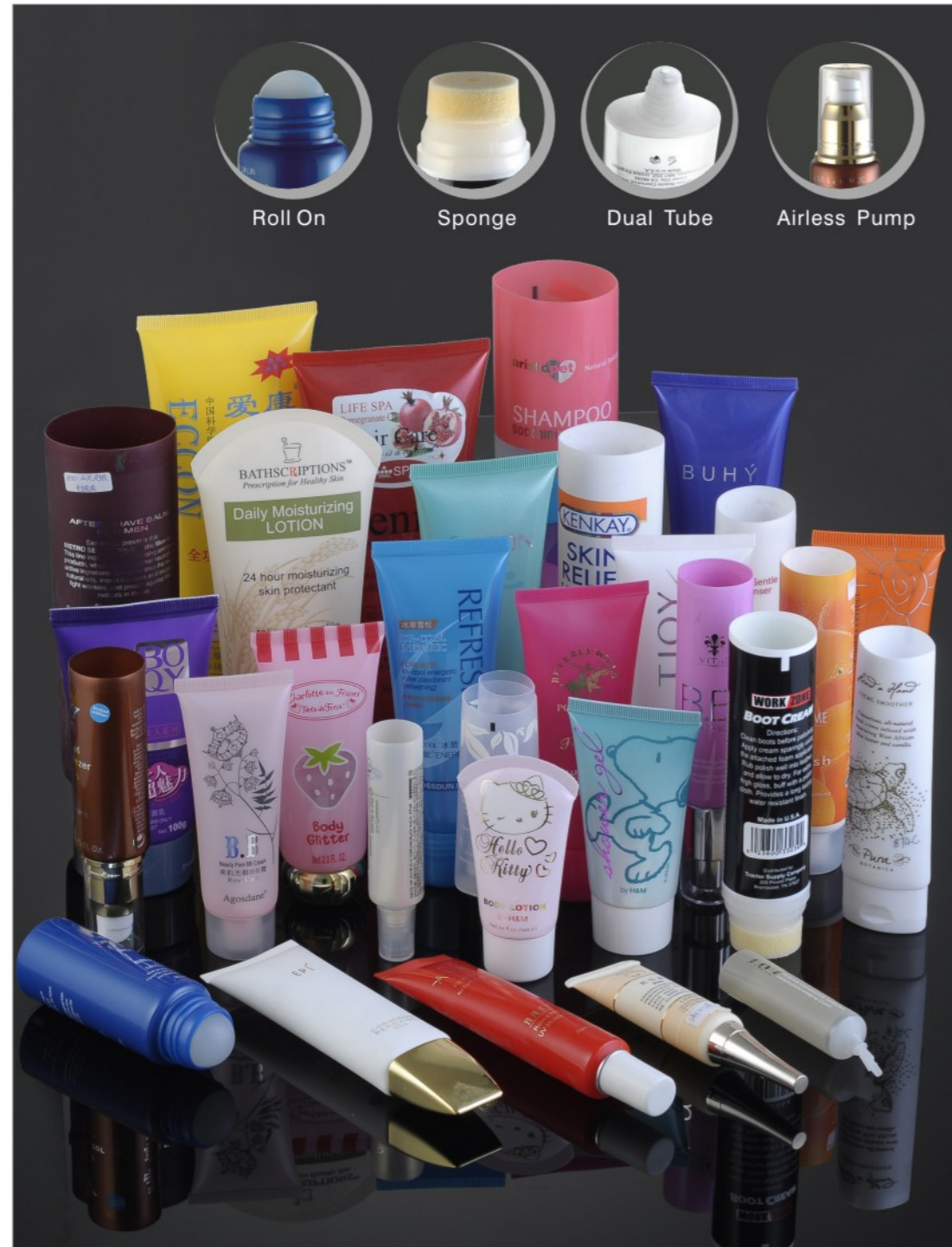

Plastic Tube series

塑料软管系列

VOLUME TO SIZE CHART

Inches>	1/2"	5/8"	3/4"	7/8"	1"	1 3/16"	1 3/8"	1 9/16"	1 3/4"	2"	2 3/8"	2 3/8"	
Millimeter	13	16	19	22	25	30	35	40	45	50	55	60	
ML	fl oz												
3	0.10	50											
5	0.17	60	65	60									
8	0.27	85	70	70									
10	0.34		75	75									
15	0.51			85	67								
20	0.68			95	85	70							
25	0.85				105	80	70	65					
30	1.00					90	75	70	60				
35	1.18					100	82	78	65				
40	1.35					110	90	85	70				
45	1.52					120	98	90	75				
50	1.69					130	105	95	80				
55	1.86					135	113	100	85				
60	2.00					140	121	105	90				
65	2.20						129	110	95				
70	2.37						137	115	100				
75	2.54						145	120	105				
80	2.71						150	125	110				
85	2.87							130	115				
90	3.04							135	120				
95	3.21							140	125	100			
100	3.38							145	130	105			
110	3.72							150	135	115			
120	4.06							155	140	125	105		
125	4.23							160	145	130	108		
130	4.40							165	150	145	111		
135	4.57								155	150	114		
140	4.73								160	155	117		
145	4.90								165	160	120		
150	5.07								170	165	123		
155	5.24								175	170	126		
160	5.41								180	175	129		
165	5.58								185	180	132		
170	5.75									185	135	120	
175	5.92										138	123	
180	6.09										141	126	
185	6.26										144	129	
190	6.43										147	133	
195	6.59										150	137	
200	6.76										153	140	120
210	7.10										159	147	125
220	7.44										165	154	130
230	7.78										171	161	135
240	8.12										177	168	140
250	8.45										183	175	145
260	8.79											182	150
270	9.13												155
280	9.47												160
290	9.81												165
300	10.14												185
360	12.17												200

PE tube dia wall thickness tolerance

D16	0.38	+/-0.01	D35	0.46	+/-0.02	AL tube inner dia					
D19	0.41	+/-0.015	D40	0.46	+/-0.02	D19	18.35	0.5	D30	29.35	0.5
D22	0.42	+/-0.015	D45	0.50	+/-0.02	D22	21.3	0.5	D35	34.4	0.5
D25	0.43	+/-0.015	D50	0.51	+/-0.02	D25	24.35	0.5	D38	37.3	0.5
D30	0.46	+/-0.015	D55	0.53	+/-0.02	D28	27.35	0.5			



Cosmetic Pen series
化妆笔系列

AVAILABLE TIPS

Ordinary Tips



Anti-leak Tips

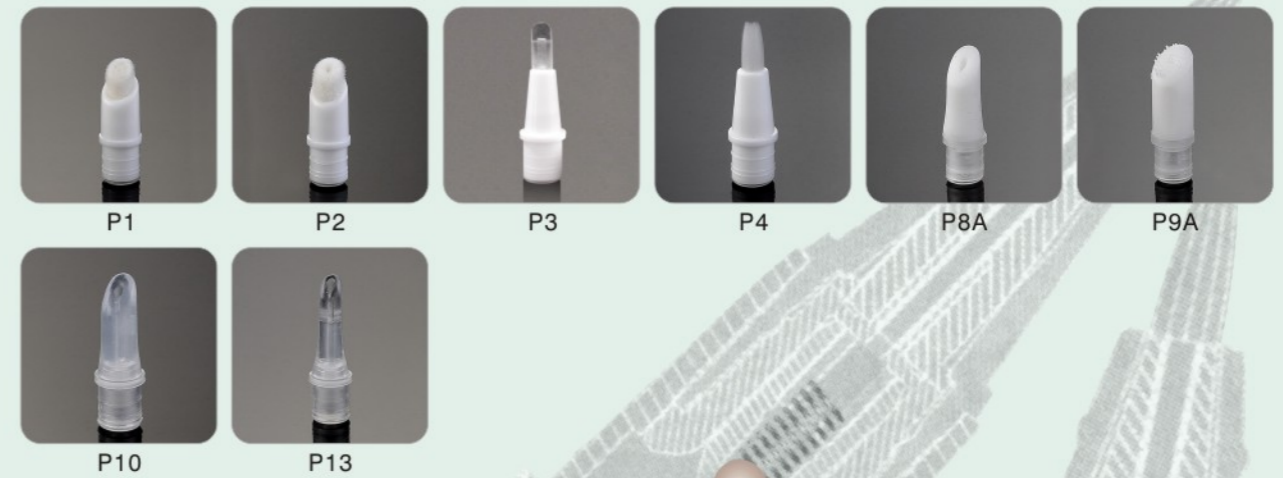

Cosmetic Pens / 化妆笔

MP10 series

MP10 series



1.0ml **900** 1.4ml **960** 1.4ml **L960** 2.0ml **C108** 2.0ml **LC108** 2.0ml **ZG128** 2.0ml **Z128** 4.0ml **C120** 4.0ml **LC120**

Available Tips: T1, T2, T12, T17, P1, P2 Available Tips: T1, T2, T4, T11, T12, T13, T17, T18, P1, P2, P3, P4, P8A, P9A, P10, P13 Available Tips: T1, T2, T4, T11, T12, T13, T17, T18, P1, P2, P3, P4, P8A, P9A, P10, P13 Available Tips: G1, G2, G4, G6 Available Tips: T1, T2, T4, T11, T12, T13, T17, T18, P1, P2, P3, P4, P8A, P9A, P10, P13



6.0ml **Z135** 3.0ml **X135** 3.0ml **X133** 6.0ml **X127** 3.0ml **X110**

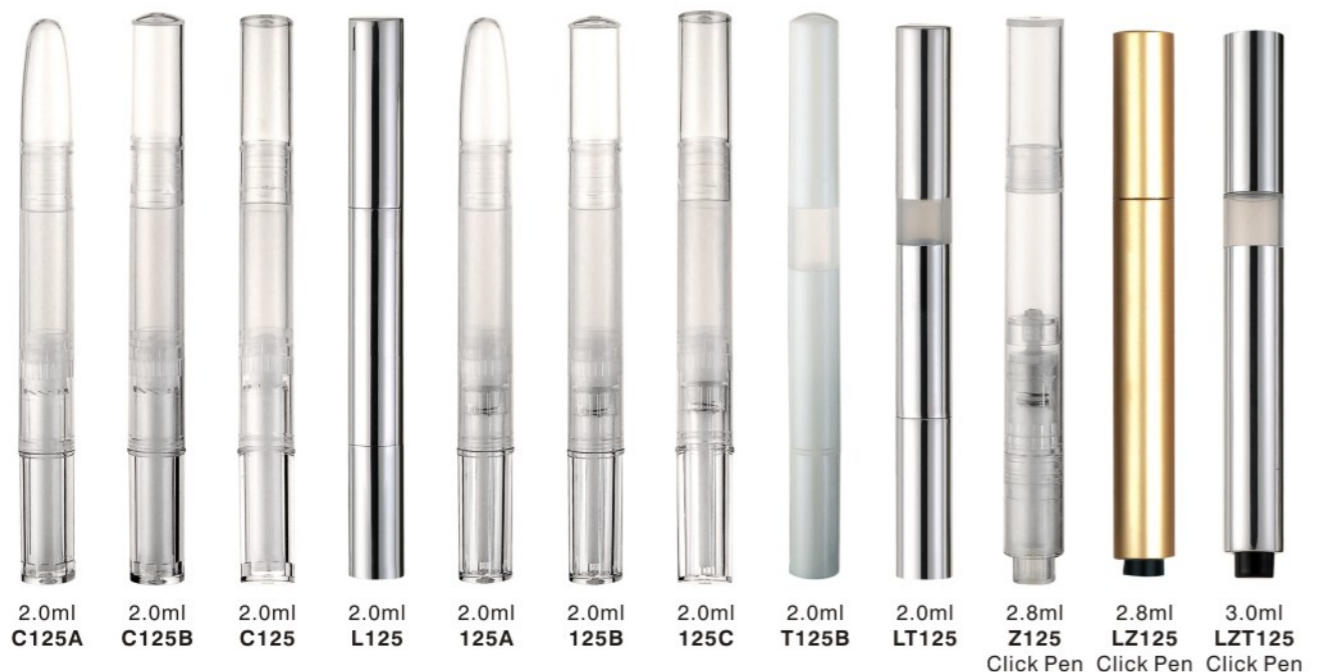

2.0ml **C125A** 2.0ml **C125B** 2.0ml **C125** 2.0ml **L125** 2.0ml **125A** 2.0ml **125B** 2.0ml **125C** 2.0ml **T125B** 2.0ml **LT125** 2.8ml **Z125** 2.8ml **LZ125** 3.0ml **LZT125**
Click Pen Click Pen Click Pen

Available Tips: T1, T2, T4, T11, T12, T13, T17, T18, P1, P2, P3, P4, P8A, P9A, P10, P13



5.0ml **Z110Z** 3.0ml **Z308** 1.8ml **Z301** 2.5ml **Z304** 2.0ml **Z201** 0.7ml **Z107**